

Operating Instructions

Translation of the Original Operating Instructions

arium® mini plus | arium® mini | arium® mini essential

H20-MA-... | H20-MM-... | H20-MU-...

Ultrapure Water System



Contents

1 About this Document	6
1.1 Validity.....	6
1.2 Symbols Used.....	6
1.2.1 Warnings in Action Descriptions.....	6
1.2.2 Other Symbols.....	6
2 Safety Notes	7
2.1 Intended Use.....	7
2.2 Personnel Qualification.....	7
2.3 Significance of These Instructions.....	8
2.4 Flawlessness of the Device.....	8
2.5 Electrical Equipment.....	9
2.5.1 Damage to the Electrical Equipment of the Device.....	9
2.5.2 Working on the Electrical Equipment of the Device.....	9
2.5.3 Power Supply and Power Cord.....	9
2.6 Accessories, Consumables and Spare Parts.....	9
3 Device Description	10
3.1 Device Overview.....	10
3.2 Electrical Connections.....	11
3.3 Water Connections.....	11
3.4 Tubing.....	12
3.4.1 Feed Water Tubing.....	12
3.4.2 Tank Filling Tubing.....	12
3.4.3 Drain Water Tubing.....	12
3.4.4 Tank Outlet Tubing with Ball Cock.....	12
3.4.5 Dispense Tube.....	12
3.5 Ultrapure Water Treatment.....	13
3.5.1 System Setup.....	13
3.5.2 Feed Water Intake.....	14
3.5.3 Treatment Stages.....	14
3.5.4 Final Purification Stage.....	15
3.5.5 Circulation of the Ultrapure Water.....	15
4 Operating Design	16
4.1 Dispensing Mode.....	16
4.2 Message Display.....	17
4.3 Messages in Dispensing Mode.....	18
4.4 Message List.....	19
4.5 Menu.....	20
4.6 Navigating Menus.....	21
4.7 Numeric Keypad.....	22
4.8 Menu Structure.....	23
4.9 Parameters of the "Settings" Menu.....	25
4.10 Parameters of the "Care" Menu.....	26
5 Installation	27
5.1 Equipment Supplied.....	27
5.2 Prerequisites for Installation at the Installation Location.....	28
5.3 Unpacking and Setting up the Device.....	28

6	Startup	29
6.1	Connecting the AC Adapter	29
6.2	Starting up the Device	31
6.2.1	Startup Overview	31
6.2.2	Setting the Language	31
6.2.3	Starting Startup Mode	32
6.2.4	Setting the Date and Time	32
6.2.5	Setting Displayed Values	33
6.3	Inserting Pretreatment Cartridge (only arium® mini plus)	34
6.4	Inserting Ultrapure Water Cartridge	35
6.5	Inserting Bag (only arium® mini plus or arium® mini)	36
6.6	Connecting Tubing	38
6.6.1	Connecting Feed Water Tubing (only arium® mini plus or arium® mini)	38
6.6.2	Connecting Tank Filling Tubing (only arium® mini)	38
6.6.3	Connecting Drain Water Tubing (only arium® mini plus or arium® mini)	39
6.6.4	Connecting the Tank Outlet Tubing (only arium® mini plus or arium® mini)	39
6.7	Rinsing Pretreatment Cartridge (only arium® mini plus)	40
6.8	Rinsing the Ultrapure Water Cartridge	41
6.8.1	Filling of the Bag (only arium® mini plus and arium® mini)	41
6.8.2	Performing a Rinse Cycle	42
6.8.3	Re-filling the Bag During the Rinse Cycle (only arium® mini)	42
6.8.4	Completing the Rinsing Process	43
6.9	Connecting the Final Filter	44
6.10	Rinsing the Final Filter	44
7	Operation	45
7.1	Turning the Device On and Off	45
7.2	Dispensing Ultrapure Water	45
7.2.1	Preparing to Dispense Ultrapure Water	45
7.2.2	Manually Dispensing Ultrapure Water	46
7.2.3	Volume-controlled Dispensing of Ultrapure Water	46
7.2.4	Confirming Dispensing Cancelation	47
7.2.5	Ending Dispensing via Outlet Tubing	48
7.2.6	Removing Pure Water from the Bag (only arium® mini plus or arium® mini)	48
7.3	Opening the Menu	48
7.4	Manually Filling the Bag (only arium® mini)	49
7.4.1	Starting Manual Filling Using the Wizard	49
7.4.2	Starting Manual Filling in the Menu	49
7.5	Activating or Deactivating Standby Mode	50
7.5.1	Automatic ECO Mode	50
7.6	Changing System Settings	51
7.7	Performing Volume Adjustment	52
8	Cleaning and Maintenance	53
8.1	Cleaning	53
8.1.1	Cleaning the Display	53
8.1.2	Cleaning the Device Housing	53
8.2	Maintenance Schedule	54
8.3	Opening the "Care" Menu	54

8.4	Displaying Reminders	55
8.5	Replacing Consumables	55
8.5.1	Selecting Consumables for Replacement	55
8.5.2	Replacing Bag (only arium® mini plus or arium® mini)	56
8.5.3	Replacing Pretreatment Cartridge (only arium® mini plus)	58
8.5.4	Replacing Ultrapure Water Cartridge	59
8.5.5	Replacing the UV Lamp	60
8.5.6	Changing Final Filter	62
8.6	Enabling, Disabling or Configuring Reminders for Replacing Final Filters	63
8.7	Carrying Out Depressurization	63
8.8	Carrying Out Venting	64
9	Malfunctions	66
9.1	Error Messages	66
9.2	Warning Messages	68
9.3	Additional Faults	69
10	Storage and Shipping	70
10.1	Storage	70
10.2	Returning Device and Parts	70
11	Decommissioning	70
12	Transport	71
12.1	Transporting the Device	71
13	Disposal	71
13.1	Information on Decontamination	71
13.2	Disposing of Device and Parts	72
13.2.1	Information on Disposal	72
13.2.2	Disposal	72
14	Technical Specifications	73
14.1	Power Supply	73
14.2	Ambient Conditions	73
14.3	Safety of Electrical Equipment	74
14.4	Electromagnetic Compatibility	74
14.5	Product Water Quality	74
14.5.1	arium® mini plus	74
14.5.2	arium® mini and arium® mini essential	75
14.6	Feed Water Quality	75
14.6.1	arium® mini plus	75
14.6.2	arium® mini	76
14.6.3	arium® mini essential	76
14.7	Device Properties	76
15	Consumables	77
16	Sartorius Service	77
17	Conformity	77
17.1	EU Declaration of Conformity	77
17.2	CSA Declaration of Conformity	77

1 About this Document

1.1 Validity

These instructions are part of the device. These instructions apply to the device in the following versions:

Device	Model name
arium® mini plus	H20-MA-UV-T H20-MA-T H20-MA-UV-T-US H20-MA-T-US
arium® mini	H20-MM-UV-T H20-MM-T H20-MM-UV-T-US H20-MM-T-US
arium® mini essential	H20-MU-UV-T H20-MU-T H20-MU-UV-T-US H20-MU-T-US

1.2 Symbols Used

1.2.1 Warnings in Action Descriptions

WARNING

This symbol denotes a danger with risk that death or severe injury may result if it is **not** avoided.



CAUTION

Denotes a danger with risk that moderate or minor injury may result if it is **not** avoided.

NOTICE

Denotes a danger that can result in property damage if the risk is **not** avoided.

1.2.2 Other Symbols

-  Required action: Describes activities that must be performed.
-  Result: Describes the result of the activities carried out.
- [] Text inside brackets refers to control and display elements.

Figures on the Operating Display

Depending on your device configuration, the figures on the operating display of your device may deviate from those in these instructions.

2 Safety Notes

2.1 Intended Use

The device is a water purification system that produces "ASTM Type 1" ultrapure water for daily requirements of up to 10 liters.

The device is intended exclusively for use in accordance with these instructions. Any further use beyond this is considered **improper**.

If the device is **not** used properly: The protective systems of the device may be impaired. This can lead to unforeseeable personal injury or property damage.

Operating Conditions for the Device

Do **not** use this device in potentially explosive environments. The device may only be used indoors.

The device may only be used with the equipment and under the operating conditions described in the Technical Data of these instructions.

Modifications of the Equipment

You may **not** modify the device or make any technical changes on your own. Any retrofitting or technical changes to the device are only permitted with prior written permission by Sartorius.

Foreseeable Misuse

Using the device is only safe when it is operated in accordance with its intended use. The following applications, for example, are **not** permitted:

- Operation outside the permissible ambient conditions (see Chapter "14 Technical Specifications," page 73) e.g. extreme temperatures, chemical vapors, moisture, shock, vibration or strong electromagnetic fields
- Carrying out unauthorized modifications or other technical changes on the device
- Connecting unsuitable devices
- Installation of unauthorized items on or in the device

2.2 Personnel Qualification

These instructions are addressed to the target groups mentioned below. All persons working on the device must possess the stated knowledge and authorizations.

If **no** qualifications are indicated for the actions described in these instructions: The actions described are addressed to the "user" target group.

If individual actions must be carried out by other target groups or by Sartorius Service personnel: The qualification required will be indicated in the description of the action.

Target group	Knowledge / responsibilities
User	<p>The user is familiar with the operation of the device and the associated work processes. He knows the dangers that can occur when working with the device and can avoid these dangers.</p> <p>The user has been trained in the operation of the device. The training is carried out by the operating engineer / laboratory manager or the operator of the device.</p>

Target group	Knowledge / responsibilities
Operating engineer / laboratory manager	The operating engineer / laboratory manager makes decisions about the use and parameterization of the device. The operating engineer / laboratory manager is trained in the operation of the device. The training is performed by Sartorius Service or the operator.
Operator	The operator of the device is responsible for compliance with safety requirements and workplace safety regulations. The operator must ensure that all persons who work with the device have access to the relevant information and have been instructed in work with the device.

2.3 Significance of These Instructions

Failure to follow these instructions can have serious consequences, e.g. exposure of individuals to electrical, mechanical or chemical hazards.

- ▶ Before working with the device: Read the instructions carefully and completely.
- ▶ If the instructions are lost: Request a replacement or download the latest instructions from the Sartorius website (www.sartorius.com).
- ▶ The information contained in these instructions must be made available to all individuals working with the device.

2.4 Flawlessness of the Device

Damaged equipment or worn-out parts can cause malfunctions or lead to hard-to-detect hazards.

- ▶ Only operate the device when it is safe and in perfect working order.
- ▶ Observe the maintenance intervals (intervals and maintenance tasks, see Chapter "8.2 Maintenance Schedule," page 54).
- ▶ Have any damage repaired immediately by Sartorius Service.

2.5 Electrical Equipment

2.5.1 Damage to the Electrical Equipment of the Device

Damage to the electrical equipment of the device, e.g. damage to the insulation, can be life-threatening. Contact with parts under voltage represents a direct danger to life.

- ▶ If the electrical equipment of the device is defective, immediately switch off the power supply and contact Sartorius Service.
- ▶ Keep live parts away from moisture. Moisture can cause short circuits.
- ▶ Make sure that the power connection is equipped with a ground lead.

2.5.2 Working on the Electrical Equipment of the Device

Any work on or modifications to the electrical equipment of the device may only be carried out by Sartorius Service personnel. The device may only be opened by Sartorius Service personnel.

2.5.3 Power Supply and Power Cord

Serious injury can result, e.g. from electric shocks, if an unsuitable power supply or an unsuitable / inadequately dimensioned power cords is used.

- ▶ Use only original power supplies and original power cords.
- ▶ Do **not** use inadequately dimensioned power cords.
- ▶ If the power supply or the power cord must be replaced: Contact Sartorius Service. Do **not** repair or modify the power supply or power cord.

2.6 Accessories, Consumables and Spare Parts

The use of unsuitable accessories, consumables and spare parts can affect the functionality of the device, be hazardous and have the following consequences:

- Risk of injury to persons
 - Damage to the device
 - Malfunctions of the device
 - Total failure of the device
-
- ▶ Only use accessories, consumables and spare parts from Sartorius. Sartorius can provide information on operational quality upon request.
 - ▶ Only use accessories, consumables and spare parts that are in technically perfect condition.

3 Device Description

3.1 Device Overview



Fig.3-1: arium® mini plus (example)

No.	Description
1	Display with touch function
2	Water outlet
3	Final filter
4	Front cover
5	Side cover

3.2 Electrical Connections



Fig.3-2: Electrical connections on the arium® mini plus (example)

No.	Description	Explanation
1	"USB" connection	For Sartorius Service
2	"Power" connection	For connection of the AC adapter (power supply)

3.3 Water Connections

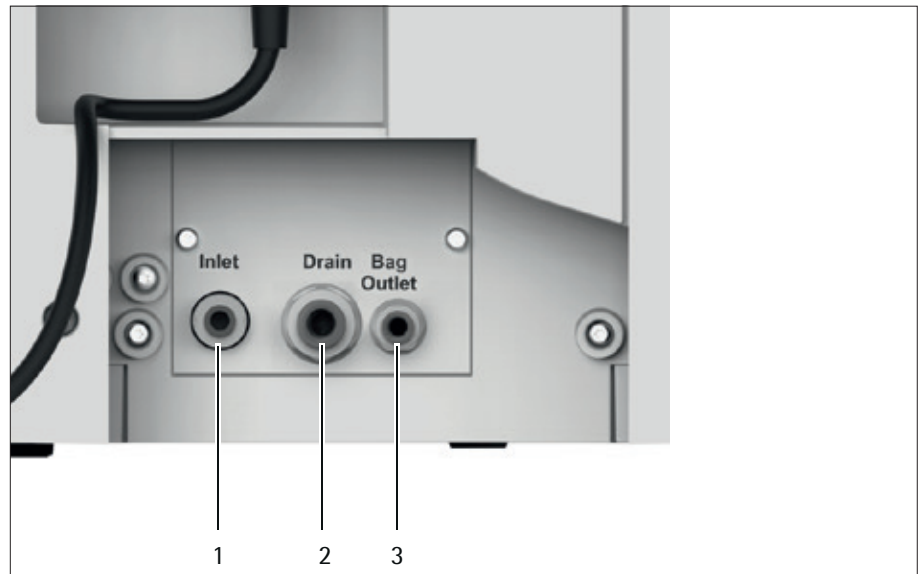

Fig.3-3: Water connections on the arium® mini plus (example)

No.	Description	Explanation
1	"Inlet" connection	For connecting the tank filling tubing or feed water tubing
2	"Drain" connection	For connecting the waste water tubing (only arium® mini plus and arium® mini)
3	"Bag Outlet" connection	For connecting the tank outlet tubing (only arium® mini plus and arium® mini)

3.4 Tubing

3.4.1 Feed Water Tubing

The feed water tubing is used to supply feed water to the device:

- arium® mini plus: Supply of tap water
- arium® mini essential: Supply of pretreated water

The feed water tubing is marked "Inlet".



3.4.2 Tank Filling Tubing

The tank filling tubing serves to feed pretreated water from an external tank to the device (only arium® mini).

The tank filling tubing is marked "Inlet".



3.4.3 Drain Water Tubing

The drain water tubing is used to drain unpurified water and rinse water out of the device.

The drain water tubing is marked "Drain".



3.4.4 Tank Outlet Tubing with Ball Cock

Pure water can be dispensed without pressure directly from the bag via the tank outlet tubing with ball cock. This option can be used to empty the bag when performing maintenance or to dispense pretreated water directly from the bag for further use.

The tank outlet tubing is marked "Bag Outlet".



3.4.5 Dispense Tube

The dispense tube is used for rinsing functions during startup and maintenance as well as when dispensing larger volumes of water.



3.5 Ultrapure Water Treatment

3.5.1 System Setup

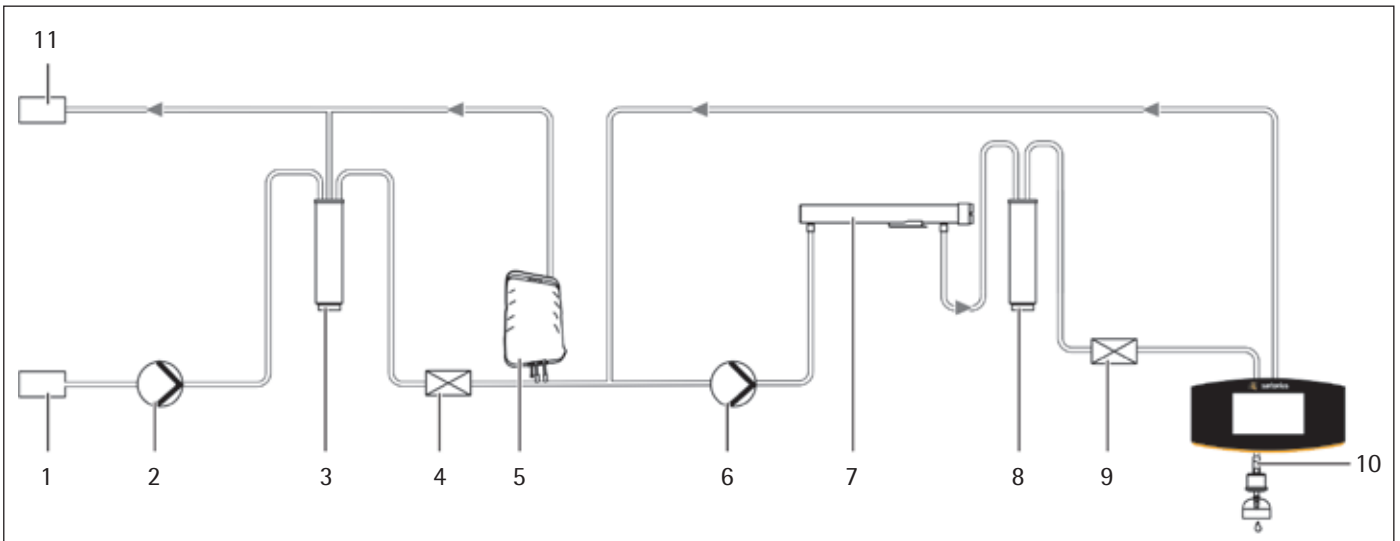

Fig.3-4: arium® mini plus system setup

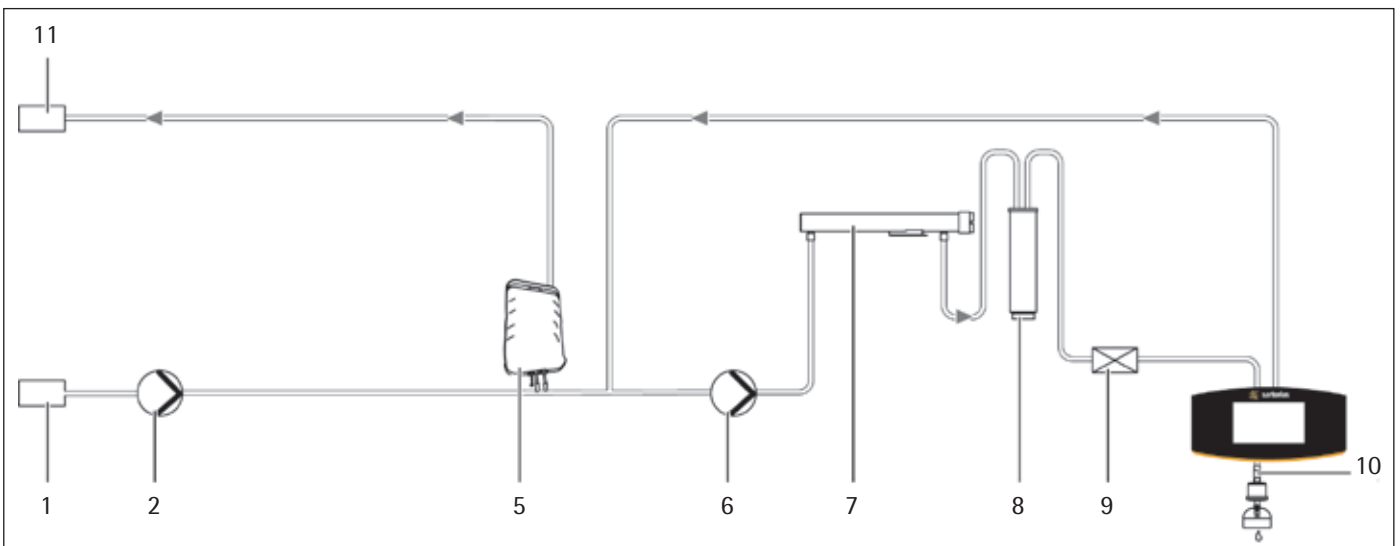

Fig.3-5: arium® mini system setup

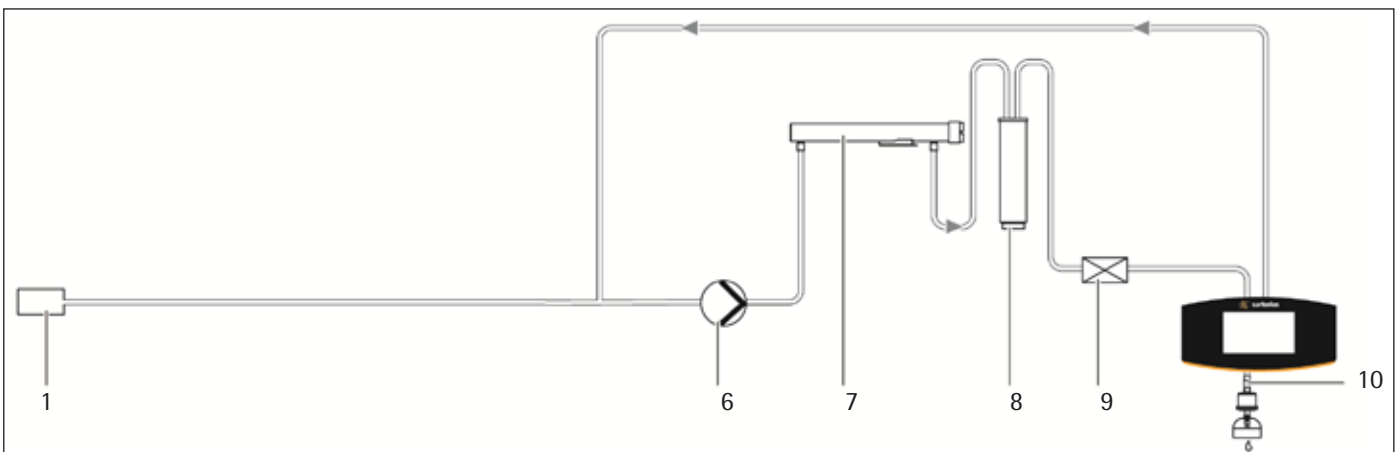

Fig.3-6: arium® mini essential system setup

No.	Description	No.	Description
1	Inlet (feed water)	7	UV lamp (185/254 nm)
2	Pump	8	Ultrapure water cartridge (Scientific Pack)
3	Pretreatment cartridge	9	Conductivity measurement
4	Conductivity measurement	10	Product water outlet
5	Bag	11	Outlet (drain water)
6	Pump		

3.5.2 Feed Water Intake

The feed water intake differs according to the device type:

Device type	Feed water intake
arium® mini plus	Direct connection to tap water connection possible, automatic filling of the bag
arium® mini	Manual filling of the bag with pretreated water
arium® mini essential	Direct connection to pretreated water

3.5.3 Treatment Stages

Device type	Required treatment stages
arium® mini plus	Pretreatment stage, ultrapure water stage
arium® mini	Ultrapure water stage
arium® mini essential	Ultrapure water stage

Pretreatment level (first treatment stage)

In the first treatment stage, the tap water is treated with pretreated water: The feed water is passed through the pretreatment cartridge by means of a membrane pump. The pretreatment cartridge contains a combination of activated carbon, catalyst and downstream reverse osmosis. The pretreatment cartridge removes particles, salts and impurities, e.g. chlorine, from the tap water.

A large proportion of the impurities are discarded by means of a concentrate outlet (drainage water outlet).

The treated water is stored in the bag for further use. The quality of the treated water is monitored via a conductivity measuring cell (LFR).

Ultrapure water stage (second treatment stage)

In the second treatment stage, the pretreated water is purified to ultrapure water (ASTM type 1): The pretreated water stored in the bag (arium® mini plus and arium® mini) or directly fed pretreated water (arium® mini essential) is fed into the ultrapure water circuit.

The water fed in can be freed from organic residues using an optional UV lamp (185/254 nm). The pretreated water is then treated using the ultrapure water cartridge (Scientific Pack).

The quality of the ultrapure water is monitored via a conductivity measuring cell (LFP).

3.5.4 Final Purification Stage

The ultrapure water passes through a final filter as it is dispensed. A sterile filter or an ultrafilter can be used as a final filter.

3.5.5 Circulation of the Ultrapure Water

To guarantee ultrapure water of consistent and high quality, the ultrapure water purification system is constructed like a circulation ring:

- If **no** water is dispensed, the water circulates through the UV lamp and the ultrapure water cartridge.
- If there is **no** interaction with the device, the device automatically switches to ECO mode.

4 Operating Design

4.1 Dispensing Mode

In dispensing mode, the display shows information on water quality and the level of the bag as well as buttons relevant to dispensing.

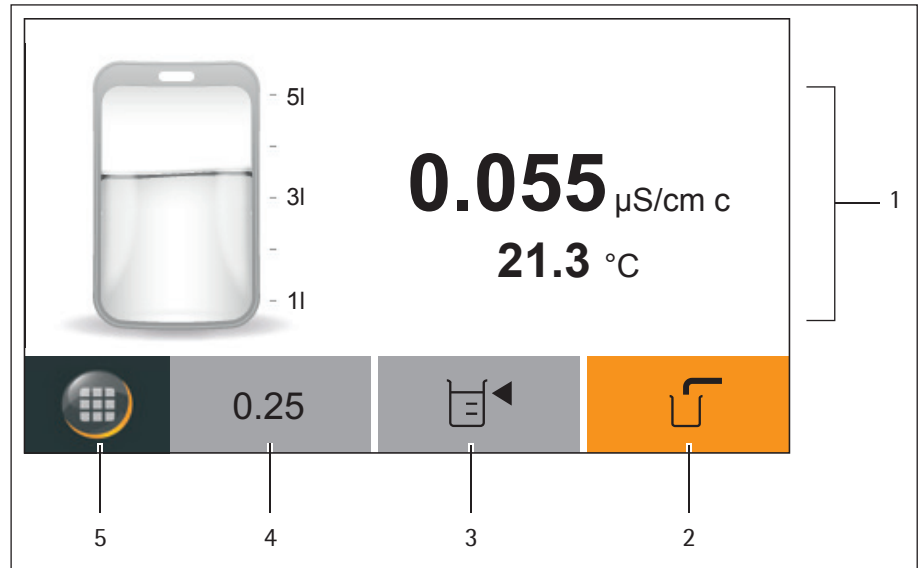

Fig. 4-1: Dispensing mode arium® mini plus (example)

No.	Symbol	Name	Description
1		Working environment	The following information can be displayed: <ul style="list-style-type: none"> – Current conductivity of the ultrapure water – Current temperature of the ultrapure water – Filling level of the bag (only arium® mini plus and arium® mini) – Messages, warnings, errors
2		Manual dispensing	Starts dispensing without a preset dispensing volume.
3		Volume-controlled dispensing	Starts dispensing after a dispensing volume has been specified.
4		Favorite	Starts dispensing the most recently specified dispensing volume.
5		Menu	Opens the menu.

4.2 Message Display

The device displays three types of messages:

- Error messages (errors):
 - Dispensing is **not** possible.
 - Details on the cause of error messages and how to troubleshoot them can be found in Chapter 9.1, page 66.
 - The user's ability to troubleshoot error messages is limited.
- Warning messages (warnings):
 - Dispensing is possible.
 - Details on the cause of warning messages and how to troubleshoot them can be found in Chapter 9.2, page 68.
 - The user can troubleshoot warning messages.
- Status messages (info):
 - Dispensing is possible.
 - Specific information requires the user's attention. Action is **not** absolutely necessary.

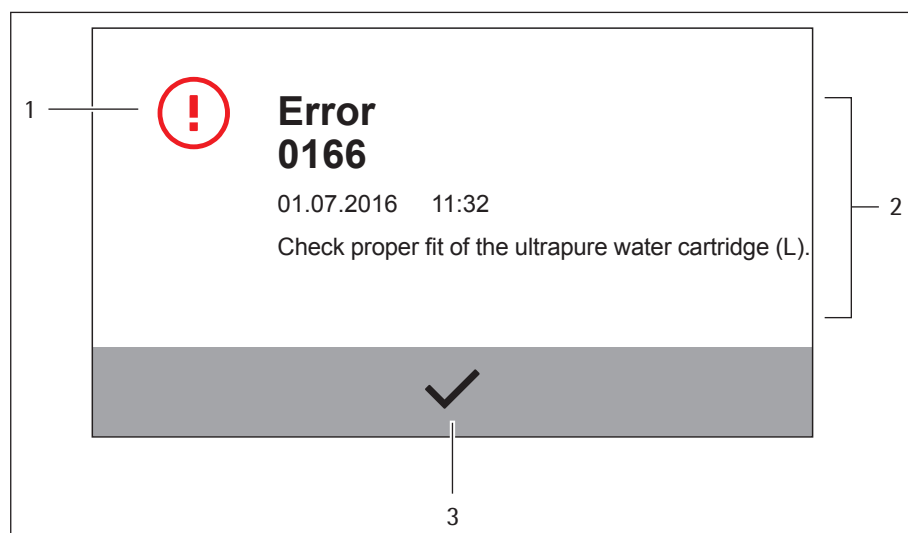









Fig. 4-2: Error message (example)

No.	Symbol	Name	Description
1	  	Message symbol	 Displays an error message.  Displays a warning message.  Displays a status message (info).
2		Message	Shows the information to be displayed: <ul style="list-style-type: none"> – Message type (error, warning, info) – Error number or brief description of a warning or status message (see Chapter 9, page 66) – Date and time of occurrence – Details on the message
3		Confirmation	Confirms the message.

4.3 Messages in Dispensing Mode

If several messages are active in dispensing mode, the message list can be called up (see Chapter "4.4 Message List," page 19). The message list only appears if several messages are active and at least one water conductivity or temperature message **cannot** be displayed. If only one message is active, the message is opened directly instead of the message list.

Dispensing is **not** possible when there is an error message. The three buttons for dispensing can be used, but when you try dispensing, the error message reappears.

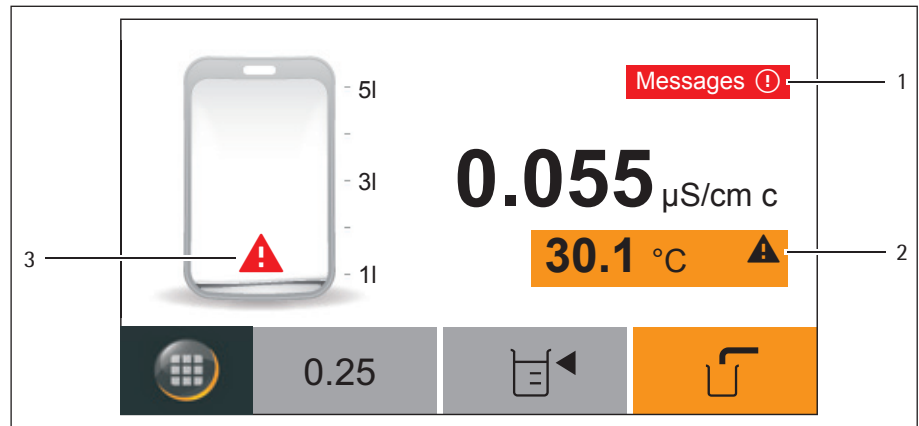

Fig. 4-3: Message display in dispensing mode (example)

No.	Symbol	Name	Description
1		Message list	Indicates that error messages are stored and opens the message list.
			Indicates that warning messages are stored and opens the message list.
			Indicates that status messages are stored and opens the message list.
2	 	Conductivity or temperature message	Displays an error or warning with respect to the water conductivity or the water temperature.
3		Message pertaining to the filling level of the bag	Indicates that the bag is empty. Water dispensing is not possible.
			Indicates that only a small amount of water can still be dispensed (only arium® mini plus and arium® mini).

4.4 Message List

All active messages can be viewed in the message list.

The messages in the message list are sorted by priority. Error messages are on top. Within the same priority level, the messages are sorted by date and time.

Messages cannot be deleted manually. They remain in the message list and continue to be displayed on the display until their cause has been corrected. The device will detect if the cause of the message has been corrected and automatically clear the message from the message list and the display.

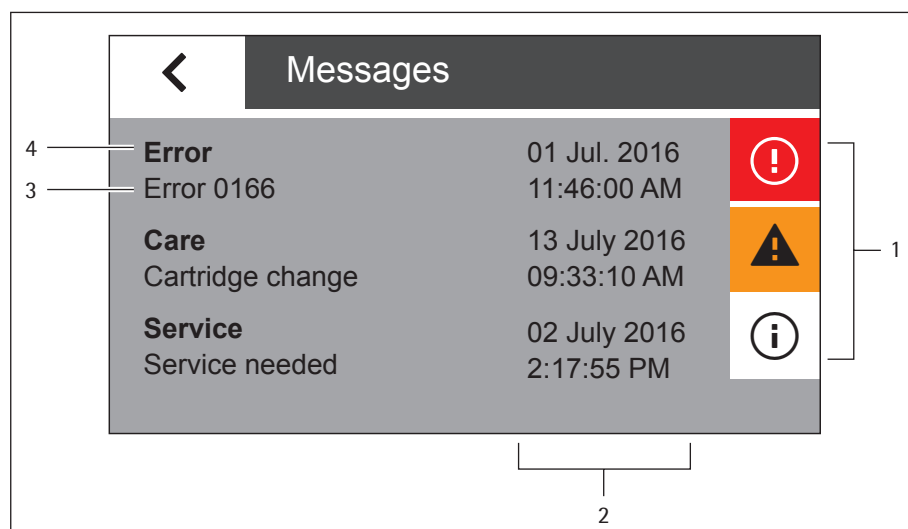







Fig. 4-4: Message list (example)

No.	Symbol	Name	Description
1	  	Message symbol	 Displays an error message.  Displays a warning message.  Displays a status message (info).
2		Occurrence of the message	Displays the date and time of occurrence of the message.
3		Brief description	Displays the error number or a short description of the message (see Chapter 9, page 66).
4		Message type	<ul style="list-style-type: none"> – Error: Displays and opens an error message. – Care: Displays and opens a warning message. – Service: Displays and opens a status message.

4.5 Menu

All system settings and operation steps for the care of the device can be carried out in the menu.

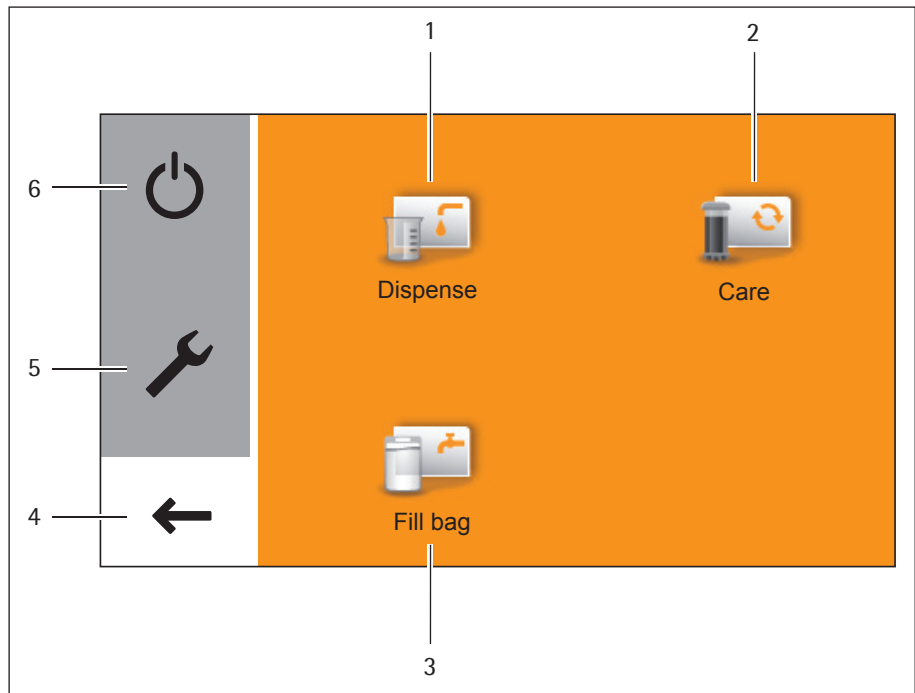







Fig. 4-5: Menu

No.	Symbol	Name	Description
1		Dispense	Opens the dispensing screen.
2		Care	Opens the "Care" menu.
3		Fill bag	Opens the bag filling wizard (only on arium® mini).
4		Back	Closes the menu.
5		Settings	Opens the "Settings" menu.
6		Standby	Switches to standby mode.

4.6 Navigating Menus

A display with touch function is used to operate the device.

If multiple menu items are available, you can scroll up and down using the touch screen to select the desired entry.

NOTICE

Sharp or pointed instruments (such as ballpoint pens) can damage the device!

When using the touch screen with the aid of objects, the touch screen can be easily damaged.

- ▶ The touch screen should only be operated by lightly pressing it using the tips of your fingers.
- ▶ The touch screen can also be operated with lab gloves.

Procedure

- ▶ To scroll: Slowly swipe the touch screen up or down.
- ▷ The menu entries move in the corresponding direction.
- ▷ During scrolling, a gray scrollbar is displayed on the right for orientation.

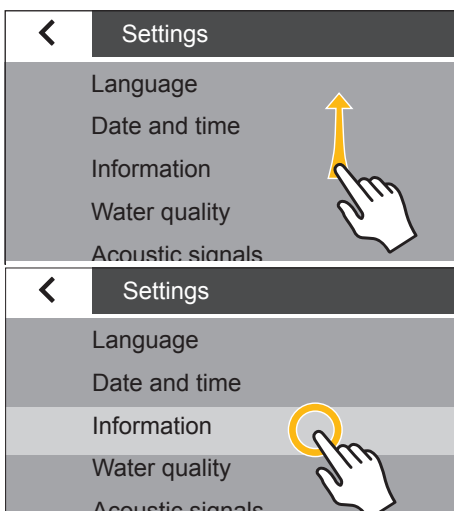

- ▶ To select a menu item: Tap the desired item.



- ▶ To confirm a selection: Tap the [✓] button.



- ▶ To cancel an operation and return to the previous screen: Tap the [x] button.



- ▶ To switch to the next higher menu level or to the previous dialog box: Tap the [←] button.



- ▶ To enter a manual value via the numeric keypad: Tap the [⋮] button.



- ▶ To confirm a message: Tap the [OK] button.



- ▶ To start a process: Tap the [START] button.



- ▶ To cancel a process: Tap the [STOP] button.

4.7 Numeric Keypad

The numeric keypad is used to enter a dispensing volume or to configure various system settings.

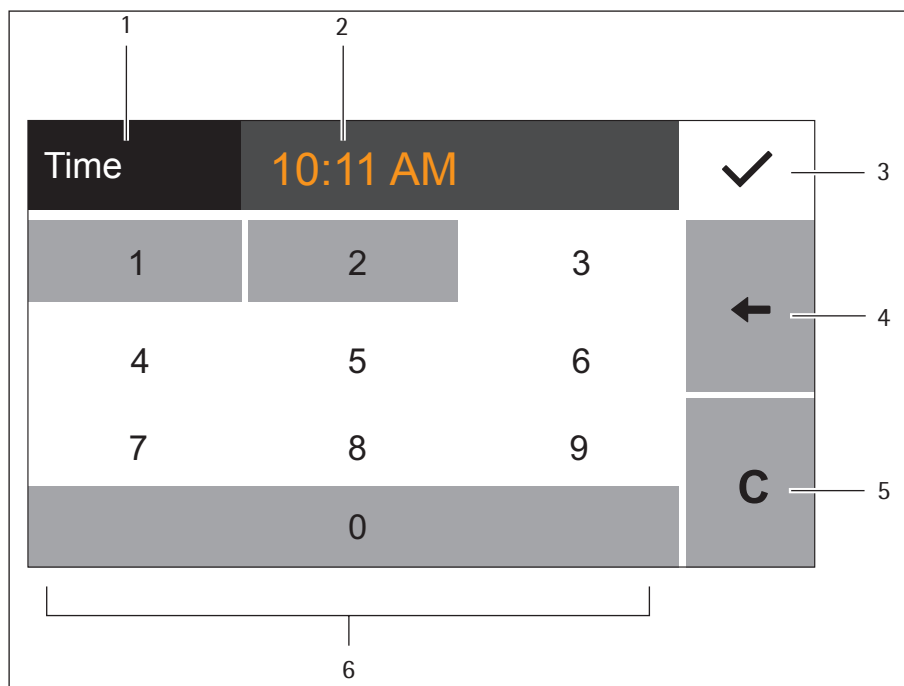

Fig. 4-6: Numeric keypad (example: Entering the time)

No.	Symbol	Name	Description
1		Name of the dialog box	Displays the name of the current dialog box.
2		Numerical value	Displays the currently entered numeric value.
3	✓	Confirmation beep	Accepts the numeric string entered and returns to the menu or dispensing mode.
4	←	Correction	Deletes the last digit entered.
5	C	Delete	Clears all digits entered.
6		Numeric Keypad	Transfers numerical values to the dialog box.

Tip



When entering numerical values, only the numbers admissible for the value can be selected.



Example: Inputting a dispensing volume of more than 5 liters is **not** possible. The numeric fields 6 to 9 are therefore inactive when entering the dispensing volume.

- Observe the validity of the numerical values.



4.8 Menu Structure

► Navigating menus (see Chapter 4.6, page 21).

Menu	Menu	Submenu	Description
	Standby		Starts standby mode.
	Settings	Language	Changes the language of the user interface.
		Date and time	Changes the date and time.
	Information	Device information	Shows all the features of the device, e.g. the model and serial number.
		Measured values	Displays the current water quality of the ultrapure water stage and pre-stage.
		Service information	Shows Sartorius contact information and the next maintenance date.
	Displayed values		Changes the display units for water quality and water temperature.
	Ultrapure water limit value		Sets a limit for the ultrapure water quality.
	Acoustic signals	Key beeps	Enables/disables beeps when pressing buttons.
		Alarm beep	Enables/disables persistent beeps for warnings.
		Error	Enables/disables beeps for error messages.
		Confirmation beep	Enables/disables beeps for expired waiting times.
	Display brightness		Changes the brightness of the display.
	Volume adjustment		Readjusts the flow rate sensor of the device.
	Reset settings		Resets the device to default settings.
	Dispensing		Opens the dispensing screen.

Menu	Menu	Submenu	Description
 Care	Reminder		Displays the times for the next required consumables changes.
	Change material	Bag	Starts a bag change (only arium® mini plus and arium® mini).
		Pretreatment cartridge	Starts a pretreatment cartridge change (only arium® mini plus).
		Ultrapure water cartridge	Starts an ultrapure water cartridge change.
		UV lamp	Starts a UV lamp change.
		Final filter	Starts a final filter change.
	Final filter reminder		Enables disables the reminder for the next required final filter change. Allows selection of final filter types.
	Depressurization		Starts a reduction of pressure in the device.
Ventilation		Starts manual flushing.	
 Fill bag			Starts manually filling the bag (only arium® mini).

4.9 Parameters of the “Settings” Menu

Parameters	Setting values	Explanation
Language	English	
	Deutsch	
	French	
	Italian	
	Spanish	
	Portuguese	
	Polish	
	Russian	
	Japanese	
Date format	DD.MM.YYYY	day.month.year
	MM/DD/YYYY	Month/Day/Year
	YYYY-MM-DD	Year-month-day, according to ISO standard (ISO)*
Time format	12 h (AM/PM)	12-hour clock notation
	24 h*	24-hour clock notation
Displayed values (water quality)	$\mu\text{S}/\text{cm}^{\text{c}}$ *	Shows the water quality on the dispensing screen in $\mu\text{S}/\text{cm}$ and compensated to 25 °C.
	$\mu\text{S}/\text{cm}$	Shows the water quality on the dispensing screen in $\mu\text{S}/\text{cm}$ as well as the water temperature.
	$\text{M}\Omega\text{cm}^{\text{c}}$	Shows the water quality on the dispensing screen in $\text{M}\Omega\text{cm}$ and compensated to 25 °C.
	$\text{M}\Omega\text{cm}$	Shows the water quality on the dispensing screen in $\text{M}\Omega\text{cm}$ as well as the water temperature.
Displayed values (temperature)	°C	Shows the water temperature on the dispensing screen in degrees Celsius.
	°F	Shows the water temperature on the dispensing screen in degrees Fahrenheit.
	Off*	Disables the display of the water temperature (only selectable if the water quality is compensated to 25 °C is displayed).
Ultrapure water limit value (activation)	On*	Enables the limit value for water quality. If the limit value is exceeded during dispensing, a warning message with a yellow warning triangle  appears. Dispensing is possible.
	Off	Disables the limit value for water quality.
Dispensing lock	On	Enables the dispensing lock. If the limit value is exceeded during dispensing, an error message with a red warning triangle  appears. Dispensing is not possible. This setting is recommended for particularly critical applications.
	Off*	Disables the dispensing lock.

* Basic settings

Parameters	Setting values	Explanation
Key beeps	On	Enables disables short beeps when you touch a button.
	Off*	
Alarm beep	On*	Enables disables the sustained beep when a warning message occurs until the warning message has been confirmed.
	Off	
Error	On*	Enables disables the sustained beep when an error message occurs until the error message has been confirmed. Does not disable the error tone in the case of a leak.
	Off	
Confirmation beep	On*	Enables disables the beep at the end of longer time sequences, e.g. after volume-controlled dispensing or after filling the bag.
	Off	
Display brightness	Bright*	Sets the display brightness to 100%.
	Dark	Sets the display brightness to 60%.
Volume adjustment		See Chapter 7.3.4, page 47.
Reset settings	Yes, reset	Restores all system settings to default, e.g. the ultrapure water limit value and the displayed values. Does not reset the dates for the reminders to change consumables.
	No	Cancels the settings reset.

* Basic settings

4.10 Parameters of the "Care" Menu

Parameters	Setting values	Explanation
Final filter reminder	Active*	Enables disables the reminder to change the final filter (see Chapter 8.7, page 58).
	Inactive	
	Sterile filters	Used for selection of the final filter type.
	Ultrafilter	
	Reminder [weeks]	Sets the time interval for the reminder. The default is 4 weeks.
Depressurization		See Chapter 8.7, page 63.
Ventilation		See Chapter 8.8, page 64.

* Basic settings

5 Installation

5.1 Equipment Supplied

	Quantity		
	arium® mini	arium® mini plus	arium® mini essential
Version as a bench system	1	1	1
Feed water tubing: PE, 4" outer diameter, 2.40 m in length with reduction connector 3/8" to 1/4" (conversion adapter) and hose (PE, 3/8" outer diameter, 0.05 m in length)	–	1	1
Drain water tubing: PE, 3/8" outer diameter, 2.40 m in length	1	1	–
Dispense tubing: PVDF, 1/4" outer diameter, 2.40 m in length	1	1	1
Tubing adapter for feed water with built-in screen: 1/2" internal thread, 3/8" external diameter	–	1	1
Tubing adapter for feed water with built-in screen: G 3/4" internal thread, 3/8" external diameter with threaded adapter G 3/4" to 1/4"	–	1	1
Tank outlet tubing: PE, 4" , 4" outer diameter, 0.10 m in length)PE, 1/4" outer diameter, 1.50 m in length with shut-off valve and hose (PE, 1/4" outer diameter in length)	1	1	–
Tank filling tubing: 1/4" outer diameter, 2.40 m in length	1	–	–
Hose release tool	1	1	1
AC adapter with country-specific power cord	1	1	1
Operating Instructions	1	1	1
QA certificate	1	1	1

Upon delivery, the following parts are located behind the left side cover of the device:

- Tubing
- Tubing adapter
- Hose release tool
- Power cord

Consumables

The consumables are **not** included in the scope of delivery:

- Pretreatment cartridge
- Ultrapure water cartridge (Scientific Pack)
- Bag
- Final filter

5.2 Prerequisites for Installation at the Installation Location

Procedure

- ▶ Make sure that the following conditions are met at the place of installation:

Requirement	Features
Ambient conditions	<ul style="list-style-type: none"> – Suitability tested (ambient conditions, see Chapter 14.2, page 73; electromagnetic compatibility, see Chapter 14.4, page 74)
Footprint	<ul style="list-style-type: none"> – Stable and level surface – Sufficient space for the device (device space requirements, see Chapter "14.7 Device Properties," page 76) – Sufficient load capacity for the device, including when it has been filled (device weight, see Chapter "14.7 Device Properties," page 76)
Access to utilities	<ul style="list-style-type: none"> – Access to utilities is a maximum of 2 meters: <ul style="list-style-type: none"> – Feed water supply – Power outlet – Pressureless drain
Feed water quality	<ul style="list-style-type: none"> – Suitability tested (see Chapter "14.6 Feed Water Quality," page 75)

5.3 Unpacking and Setting up the Device

We recommend having the installation and initial startup of the device carried out by Sartorius Service. Please contact Sartorius Service in this regard.

⚠ CAUTION

Risk of electric shock due to leaking water!

Water may spill when using the device. Electric shocks can occur if water comes into contact with electrical appliances.

- ▶ Do **not** place the device close to electrically powered devices.

⚠ CAUTION

Danger of fire or explosion!

The device contains components that can ignite highly inflammable or combustible materials.

- ▶ Do **not** operate the device in the vicinity of such substances.

Procedure

- ▶ If the device is stored: Observe the information on storage (see Chapter "10.1 Storage," page 70).
- ▶ **NOTICE** Equipment damage due to improper transport! If the device is lifted where there are loose components, it may fall and be seriously damaged.
 - ▶ **Never** lift the device by the two side covers for transport.
 - ▶ Grip the front of the device under the display and the recess for the power supply at the back of the device and lift carefully.



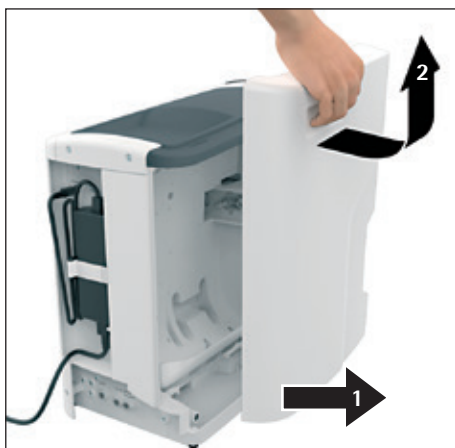

- ▶ Take the device out of the packaging and place it at the intended installation location.
- ▶ Remove the left side cover:
 - ▶ Reach behind the side cover and pull the side cover to the side (1).
 - ▶ Pull the side cover up and off to remove it (2).
- ▶ Remove the following parts from the inside of the device:
 - Tubing
 - Tubing adapter
 - Hose release tool
 - Power cord

6 Startup

We recommend having the initial startup of the device carried out by Sartorius Service. Please contact Sartorius Service in this regard.

6.1 Connecting the AC Adapter

⚠ CAUTION

Risk of electric shock due to incorrect handling of power cables!

The use of damaged or **non-standard** power cables as well as the mishandling of power cords can cause fatal electric shock or equipment damage.

- ▶ Only connect the device (protection class 1) to properly installed power sockets with protective grounding conductors (PE) with a fuse of a maximum of 16 A.
- ▶ Use only standard cables that have protective grounding conductors for operation.
- ▶ **Never** disconnect the device from the protective grounding conductor.
- ▶ Connect to the power supply according to the regulations of your specific country.
- ▶ **Never** plug the power cable into the mains wall outlet when it is disconnected from the device.
- ▶ Make sure that the power plug or another suitable disconnecting device for the power can be easily reached in case of danger.

NOTICE

Equipment damage due to operation with third-party equipment!

The use of third-party power supplies **not** authorized by Sartorius may cause damage to the device.

- ▶ Use only the original Sartorius power supply.

Procedure

- ▶ Check whether the plug design of the power cord is equivalent to your country's standard.
 - ▶ If required: Call Sartorius Service or your dealer.



- ▶ Connect the power supply to the connection labeled "Power" on the rear of the device.



- ▶ Fix the power supply to the housing using the supplied Velcro strip. To do this, pull the Velcro strip through the eyelet as shown in the figure.
- ▶ Lay the protruding power cord so that it **cannot** be damaged or obstruct subsequent connection of hoses.
- ▶ Connect the device to the AC power using the power cord.

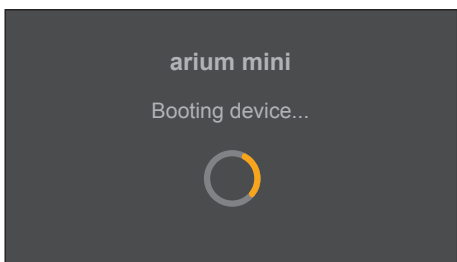

- ▶ The device starts up and performs a system scan.

6.2 Starting up the Device

6.2.1 Startup Overview

When the system check is complete, the dialog box "Language" appears. The wizard automatically performs all startup steps. Startup takes approx. 120 minutes and **cannot** be canceled.

All system settings (e.g. date, time, displayed values) that are made during the startup can be changed afterwards in the "Settings" menu (see Chapter "7.6 Changing System Settings," page 51).

Startup includes the following tasks:

Startup procedure	Chapter, page
Set the language	6.2.2, page 31
Start startup mode	6.2.3, page 32
Set date and time	6.2.4, page 32
Set the displayed values	6.2.5, page 33
Insert pretreatment cartridge (only arium® mini plus)	6.3, page 34
Insert ultrapure water cartridge	6.4, page 35
Insert bag (only arium® mini plus or arium® mini)	6.5, page 36
Connect tubing	6.6, page 38
Rinse pretreatment cartridge (only arium® mini plus)	6.7, page 40
Rinse the ultrapure water cartridge	6.8, page 41
Connect final filter	6.9, page 44
Rinse final filter	6.10, page 44

6.2.2 Setting the Language

Procedure

- ▶ Select the language for the display. The factory setting is English.
- ▶ Confirm the selection with the [✓] button.
- ▷ The dialog box "Startup" appears.

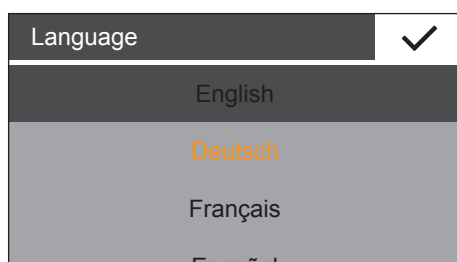

6.2.3 Starting Startup Mode

The demo mode of the device can be started by pressing the [DEMO] button. Access to demo mode is password-protected and only accessible to Sartorius employees.

Procedure

- ▶ To start startup mode: Tap the [START] button.

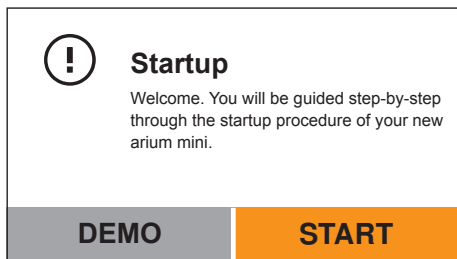

6.2.4 Setting the Date and Time

Requirements

The "Date and Time" dialog box appears.

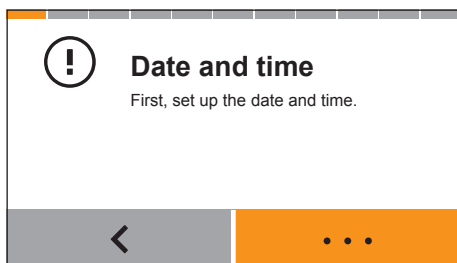

Procedure

- ▶ Tap the [...] button.
- ▶ Select the desired date format:
 - DD.MM.YYYY
 - MM/DD/YYYY
 - YYYY-MM-DD (ISO)
- ▶ Confirm the selection with the [✓] button.

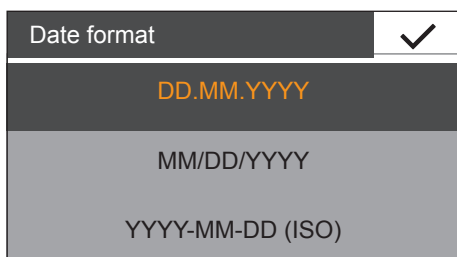

- ▶ Enter the date.
- ▶ Confirm the selection with the [✓] button.

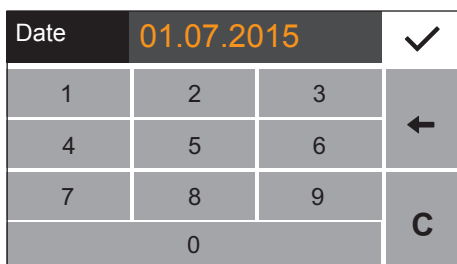

- ▶ Select the desired time format:
 - 24h
 - 12h (AM/PM)
- ▶ Confirm the selection with the [✓] button.

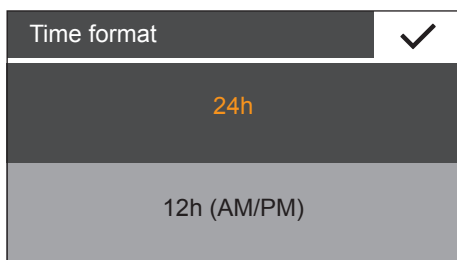

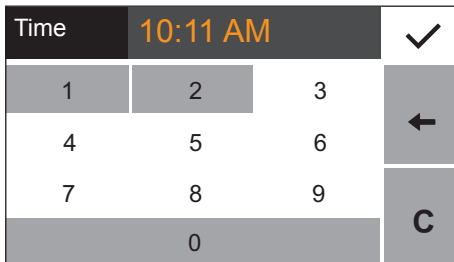

- ▶ Enter the time.
- ▶ Confirm the selection with the [✓] button.

6.2.5 Setting Displayed Values

Requirements

The "Displayed values" dialog box appears.

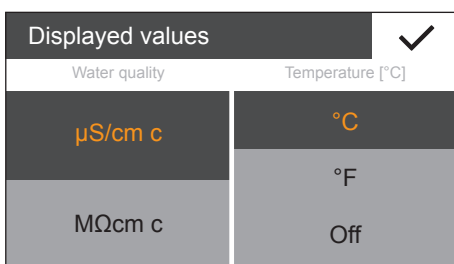
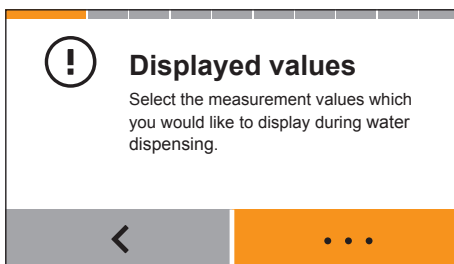

Procedure

- ▶ Tap the [...] button.
- ▶ Set the desired format for the water quality:
 - µS/cm c (compensated to 25°C)
 - MΩcm c (compensated to 25°C)
- ▶ Set the desired format for the temperature:
 - °C
 - °F
 - Off (**no** temperature display)
- ▶ Confirm the selection with the [✓] button.

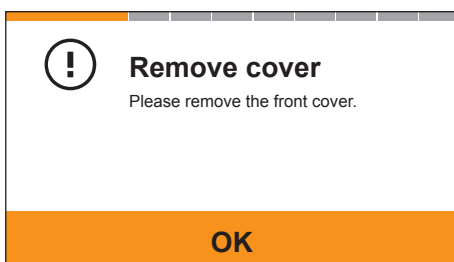

- ▶ "Remove cover" appears on the screen. Depending on the device type, a pretreatment cartridge or a cleaning cartridge must be inserted (see Chapter "6.3 Inserting Pretreatment Cartridge (only arium® mini plus)," page 34, Chapter "6.4 Inserting Ultrapure Water Cartridge," page 35).

6.3 Inserting Pretreatment Cartridge (only arium® mini plus)

A pretreatment cartridge must be inserted in the device. The cartridge holder for the pretreatment cartridge is marked "R".

Procedure

- ▶ Remove the front cover.
- ▶ Confirm removal of the cover with the [OK] button.
- ▷ The dialog box "Insert cartridge" appears.

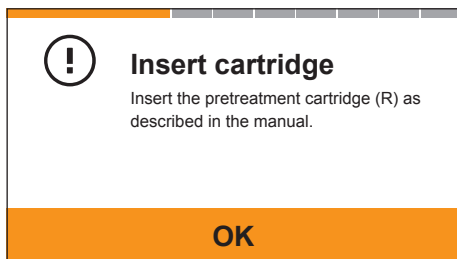

- ▶ **NOTICE** Equipment damage due to impurities! If dirt or foreign objects enter the ultrapure water circulation, individual device components can become clogged or wear out faster. Do not **touch** the connections of the pretreatment cartridge. This will prevent impurities from getting into the device.
- ▶ Remove the plugs from all three connections of the pretreatment cartridge.
- ▶ Hold the pretreatment cartridge in the upper area and insert it into the holder marked "R". To do this, push the pretreatment cartridge straight into the guide rails of the cartridge holder.



- ▶ Press the pretreatment cartridge firmly into the cartridge holder until it locks into the guide rails with a distinct clicking sound on both the left and right sides. Check that the pretreatment cartridge has been installed securely by turning it slightly.
- ▶ Confirm the insertion of the pretreatment cartridge with the [OK] button.

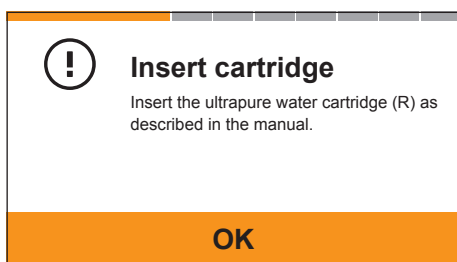

- ▷ The "Insert cartridge" dialog box (Step 2) appears. An ultrapure water cartridge must be inserted (see Chapter 6.4, page 35).

6.4 Inserting Ultrapure Water Cartridge

An ultrapure water cartridge must be inserted in the device. The cartridge holder for the ultrapure water cartridge is marked "L".

Procedure

- ▶ Remove the front cover.
- ▶ Confirm removal of the cover with the [OK] button.
- ▶ The dialog box "Insert cartridge" appears.

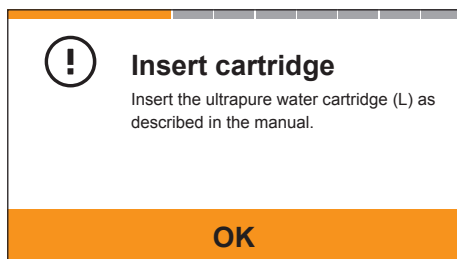

- ▶ **NOTICE** Equipment damage due to impurities! If dirt or foreign objects enter the ultrapure water circulation, individual device components can become clogged or wear out faster. Do **not** touch the connections of the ultrapure water cartridge. This will prevent impurities from getting into the device.
- ▶ Remove the plugs from the two external ultrapure water cartridge connections.
- ▶ Hold the ultrapure water cartridge in the upper area and insert it into the holder marked "L". To do this, push the pretreatment cartridge straight into the guide rails of the cartridge holder.



- ▶ Press the ultrapure water cartridge firmly into the cartridge holder until it locks into the guide rails with a distinct clicking sound on both the left and right sides. Check that the ultrapure water cartridge has been installed securely by turning it slightly.
- ▶ Confirm the insertion of the ultrapure water cartridge with the [OK] button.

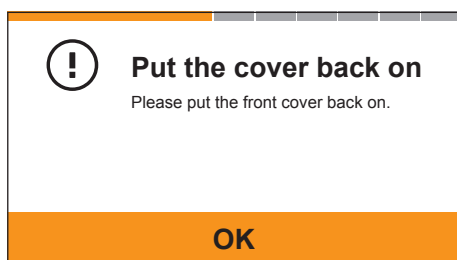

- ▶ The dialog box "Attaching the cover" appears.
- ▶ Put the front cover on the device.
- ▶ Confirm that the cover has been put on with the [OK] button.

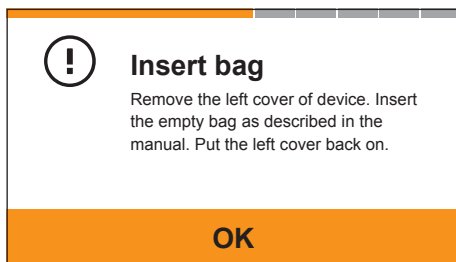

- ▶ If an arium® mini plus or arium® mini is used: The dialog box "Insert bag" appears. A bag must be inserted (see Chapter 6.5, page 36).

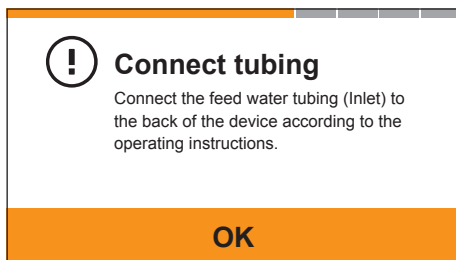

- ▶ If an arium® mini plus is used: The dialog box "Connect tubing" appears. Feed water tubing must be connected (see Chapter 6.6.1, page 38).

6.5 Inserting Bag (only arium® mini plus or arium® mini)

Procedure

- ▶ Remove the left side cover:
 - ▶ Reach behind the side cover and pull the side cover to the side (1).
 - ▶ Pull the side cover up and off to remove it (2).



- ▶ To make it easier to reach the lower connections on the device: Pull the tray up and remove it from the device.





- ▶ **NOTICE** Danger of damage to the device from improper handling! The bag may be damaged if forced into the guide rails: The bag can be damaged. Use only slight pressure when inserting the bag into the guide rail.
- ▶ Using the handle, slide the bag into the guide rail in the upper portion of the device housing. The bag is secure when the reinforcing piece on the carrying handle is completely engaged in the guide rail.



- ▶ Using the quick connector, fasten the upper hose of the bag to the device's upper connection.
- ▷ The quick connector locks into place with an audible click.
- ▶ Fasten the two lower bag hoses to the lower device connections using the quick connectors.
- ▷ The quick connectors lock into place with an audible click.

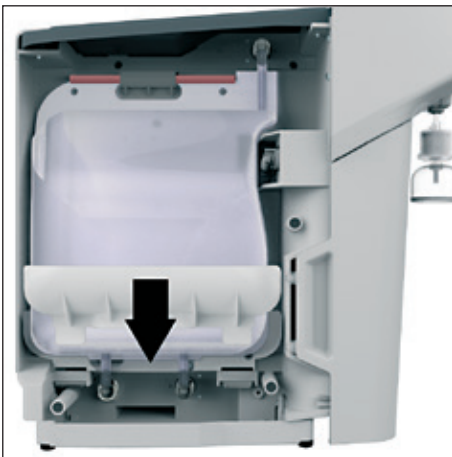

- ▶ Reinsert the tray. Make sure **not** to damage the bag.
- ▶ Reattach the left side cover of the device.
- ▶ Confirm the insertion of the bag with the [OK] button.

- ▷ The dialog box "Connect tubing" appears. Tubing must be connected (see Chapter 6.6, page 38).



Connect tubing

Connect tubing for feed water (Inlet), drain water (Drain) and tank outlet (Bag outlet) on the rear of the device as described in the manual.

OK

6.6 Connecting Tubing

6.6.1 Connecting Feed Water Tubing (only arium® mini plus or arium® mini)

To prevent the entry of particles into the device, it is recommended to use the supplied screens.

Procedure

- ▶ Connect the feed water tubing to the connection labeled "Inlet" on the rear of the device.
- ▶ **NOTICE** Water leakage due to excessive inlet pressure! If the water pressure is too high: Water can leak out of the device. Check the water pressure inlet specification (see Chapter "14.6 Feed Water Quality," page 75).
 - ▶ If required: Reduce the inlet pressure.
- ▶ **NOTICE** Water leakage can occur if feed water tubing is not watertight! If the feed water tubing is deformed or **not** inserted deep enough: Water can leak out. After startup, make sure that all external water connections are leak proof.
- ▶ Connect the feed water tubing to the feed water supply.

6.6.2 Connecting Tank Filling Tubing (only arium® mini)

To prevent the entry of particles into the device, it is recommended to use the supplied screens.

NOTICE

Contamination of tank filling tubing!

If the tank filling tubing is **improperly** stored: The tank filling tubing can be contaminated. Sufficient quality of the pure water that the bag is filled with is **no longer** guaranteed in this case.

- ▶ Do **not** leave the tank filling tubing on the floor or near sources of contamination (e.g. in the vicinity of an outlet).
- ▶ If the tank filling tubing **cannot** be kept secure while connected to the device: Remove the tank filling tubing and keep it in a clean place.
- ▶ If the tank filling tubing is contaminated:
 - Replace the bag (see Chapter 8.5.2, page 56).
 - Replace the tank filling tubing.
- ▶ Use the tank filling tubing exclusively for filling.

Procedure

- ▶ Connect the tank filling tubing to the connection labeled "Inlet" on the rear of the device.
- ▶ **NOTICE** Water leakage due to excessive inlet pressure! If the water pressure is too high: Water can leak out of the device. Check the water pressure inlet specification (see Chapter "14.6 Feed Water Quality," page 75).
- ▶ **NOTICE** Water leakage can occur if feed water tubing is not watertight! If the feed water tubing is deformed or **not** inserted deep enough: Water can leak out. After startup, make sure that all external water connections are leak proof.



6.6.3 Connecting Drain Water Tubing (only arium® mini plus or arium® mini)

NOTICE

Bag can burst due to excess pressure!

If the drain water tubing of the device is sealed off, clogged or exposed to counter-pressure, the bag may burst.

- ▶ Do **not** seal off, clog or expose the drain water tubing to counter-pressure.

Procedure

- ▶ Connect the drain water tubing to the connector labeled "Drain" on the rear of the device.



- ▶ **NOTICE** Water can leak out if drain water hose detaches! Water can escape from the drain water tubing during operation. Attach the drain water tubing to the outlet.

- ▶ Guide the free end of the waste water tubing to the drain and attach it.



6.6.4 Connecting the Tank Outlet Tubing (only arium® mini plus or arium® mini)

Procedure

- ▶ Connect the long tank outlet tubing to the connector labeled "Bag Outlet" on the rear of the device.
- ▶ Close the ball cock.
- ▶ The prompt to open and close the ball cock is shown later in the wizard.

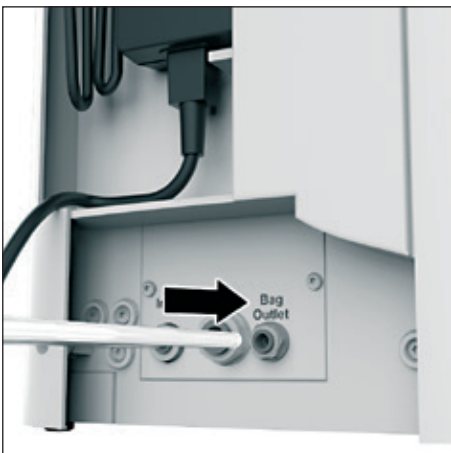

6.7 Rinsing Pretreatment Cartridge (only arium® mini plus)

Procedure

- ▶ Open the ball cock on the tank outlet tubing.
- ▶ Run the tank outlet tubing to the drain for rinsing. Water can escape from the tubing during rinsing.

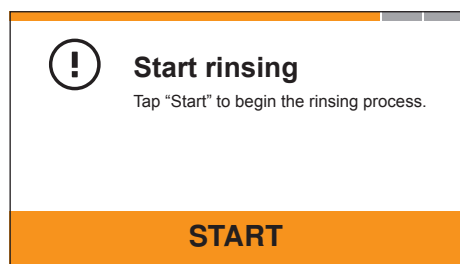
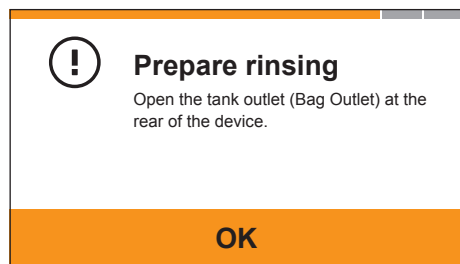

- ▶ Start the rinsing process for the pretreatment cartridge. To do this, tap the [START] button.

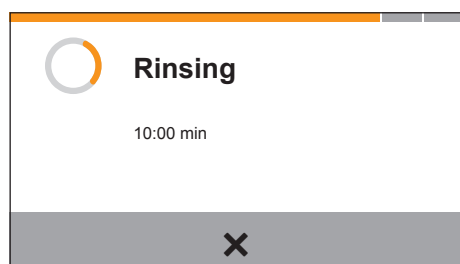

- ▷ During the rinse cycle, the remaining rinse time is displayed in minutes.
- ▶ To interrupt the rinse cycle:
 - ▶ Tap the [x] button.
 - ▷ The dialog box "Start rinsing" appears again.
- ▶ To resume the rinse cycle after an interruption: Tap the [START] button.

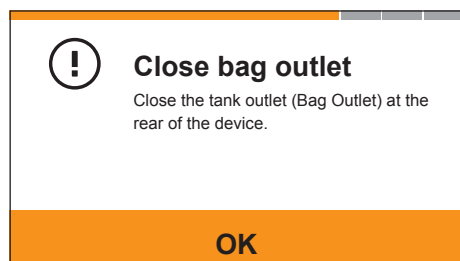

- ▶ When the rinse cycle is finished: Close the ball cock on the tank outlet tubing.
- ▶ Confirm that the tank outlet is closed. To do this, tap the [OK] button.

6.8 Rinsing the Ultrapure Water Cartridge

6.8.1 Filling of the Bag (only arium® mini plus and arium® mini)

Automatic Filling (arium® mini plus)

During rinsing, the device fills and rinses the ultrapure water cartridge. Air is removed from the ultrapure water circulation in the process.

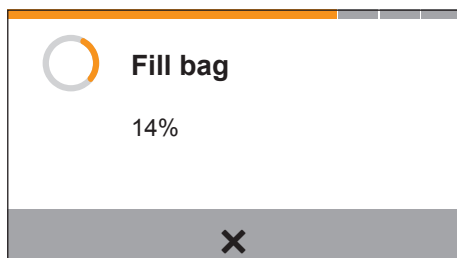

- ▷ If the bag **no longer** contains a sufficient amount of water (Tank Fill Level) or empties during the rinsing process, the bag is filled automatically.

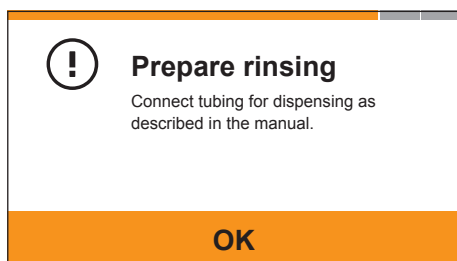

- ▷ When filling is complete, the dialog box "Prepare rinsing" appears.

Manually Filling the Bag (only arium® mini)

Procedure

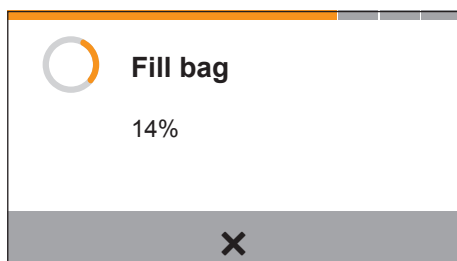

- ▶ **NOTICE** Device functions can be impaired by air intake! If there is **insufficient** water during the filling process: Air is drawn into the system. The air in the system can impair correct functioning of the device. Prepare a container with a sufficient amount of pretreated water (at least 5 liters).
- ▶ Place the tank filling tubing into the container and secure it so that its opening is completely submerged during filling.
- ▶ Tap the [START] button.
- ▷ The bag is filled with pretreated water. Progress is displayed as a percentage.
- ▶ **NOTICE** Device functions can be impaired by air intake! If there is **insufficient** water during the filling process: Air is drawn into the system. The air in the system can impair correct functioning of the device.
 - ▶ If there is **insufficient** water in the container: Cancel the filling process prematurely and fill the container with pretreated water.
- ▶ To cancel the filling process prematurely:
 - ▶ Tap the [x] button.
 - ▷ The dialog box "Fill bag" appears.
- ▶ To resume the filling cycle after an interruption: Tap the [START] button.
- ▷ When filling is complete, the dialog box "Prepare rinsing" appears. Outlet tubing must be connected (see Chapter "6.8.2 Performing a Rinse Cycle," page 42).

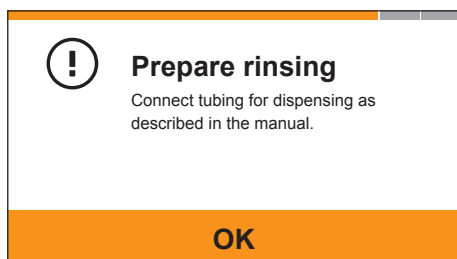

6.8.2 Performing a Rinse Cycle

During rinsing, the device fills and rinses the ultrapure water cartridge. Air is removed from the ultrapure water circulation in the process.

Procedure

- ▶ Press the dispense tube into the quick connector of the water outlet.
- ▶ Direct the free end of the dispense tube to the drain or into a vessel (at least 6 liters).



- ▶ Start the rinse cycle for the ultrapure water cartridge. To do this, tap the [START] button.

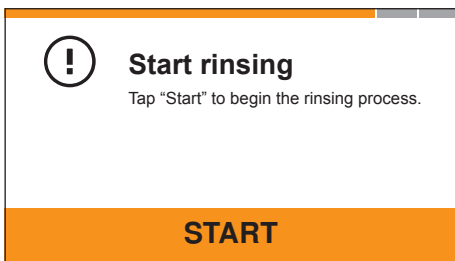

- ▷ During the rinse cycle, the remaining rinse time is displayed in minutes.
- ▶ To interrupt the rinse cycle:
 - ▶ Tap the [x] button.
 - ▷ The dialog box "Start rinsing" appears again.
- ▶ To resume the rinse cycle after an interruption: Tap the [START] button.
- ▷ The rinse cycle is performed.

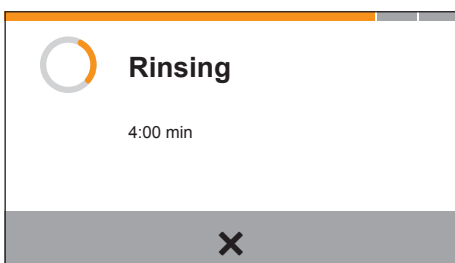

6.8.3 Re-filling the Bag During the Rinse Cycle (only arium® mini)

If the bag does **not** contain enough water or empties during the rinse cycle: The bag must be refilled.

Procedure

- ▷ The dialog box "Fill bag" appears: Fill the bag (see Chapter 6.8, page 41).

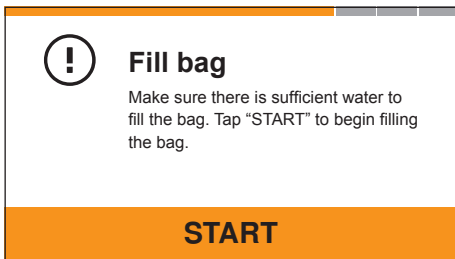

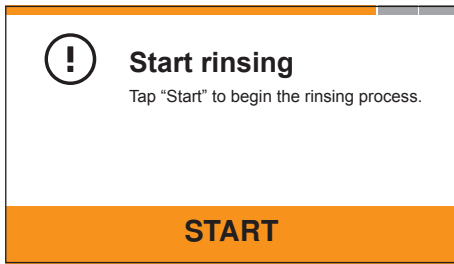

- ▶ Start the rinse cycle for the ultrapure water cartridge. To do this, tap the [START] button.

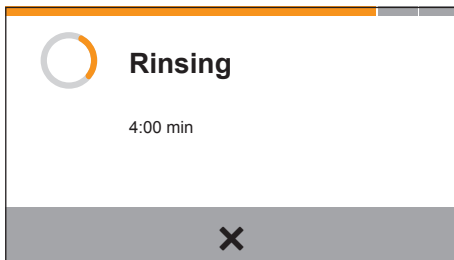

- ▶ During the rinse cycle, the remaining rinse time is displayed in minutes.
- ▶ To interrupt the rinse cycle:
 - ▶ Tap the [x] button.
 - ▶ The dialog box "Start rinsing" appears again.
- ▶ To resume the rinse cycle after an interruption: Tap the [START] button.
- ▶ The rinse cycle is performed.

6.8.4 Completing the Rinsing Process

Procedure

- ▶ When rinsing is complete, the dialog box "End rinsing" appears.

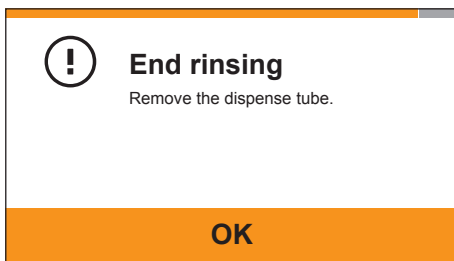

- ▶ Remove the dispense tube. To do this, use the tubing removal tool to push the dark ring of the quick connector up and pull the dispense tube down and out.
- ▶ Confirm the rinsing process with the [OK] button.

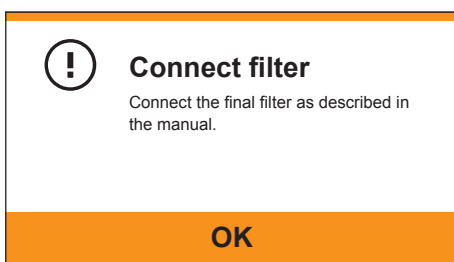

- ▶ The dialog box "Connect filter" appears. A final filter must be connected (see Chapter 6.9, page 44).

6.9 Connecting the Final Filter

Requirements

The "Connect filter" dialog box appears on the display.

Procedure

- ▶ Attach the bell assembly to the final filter.
- ▶ Press the final filter into the quick connector of the water outlet.
- ▶ Confirm that the final filter has been connected with the [OK] button.
- ▷ The display changes to the dispensing screen.



6.10 Rinsing the Final Filter

Requirements

The device is now in dispensing mode.

Procedure

- ▶ Place a vessel under the final filter.
- ▶ If a sterile filter is used as the final filter: Open the final filter's vent valve.
- ▶ Remove the protective cap from the bell assembly.
- ▶ If a sterile filter is used as the final filter: Remove at least 5 liters of water. This will rinse the final filter.
- ▶ If an ultrafilter is used as a final filter: Remove at least 20 liters of water. This will rinse the final filter.
- ▶ Only arium® mini plus or arium® mini: If the bag does **not** contain enough water or empties during the rinse cycle:
 - ▶ Wait until the bag has filled to a sufficient level.
 - ▶ Complete the rinse cycle.
- ▶ When the rinsing process is complete: Close the vent valve.
- ▶ Attach the protective cap to the bell assembly.
- ▷ Startup is complete.

7 Operation

7.1 Turning the Device On and Off

Procedure

- ▶ To turn the device on: Connect the device to the power supply.
- ▷ The device starts up and performs a system scan.
- ▶ To turn the device off: Disconnect the device from the power supply.

Tip

When the device is turned off during normal operation, e.g. in the evening or on weekends, consistent ultrapure water quality is **no** longer guaranteed. To ensure consistently high-quality ultrapure water, we recommend that you activate standby mode (see Chapter "7.5 Activating or Deactivating Standby Mode," page 50).

7.2 Dispensing Ultrapure Water

7.2.1 Preparing to Dispense Ultrapure Water

The ultrapure water can be dispensed as follows:

- Manual dispensing
- Volume-controlled dispensing

Large volumes of ultrapure water can be dispensed via the outlet tubing. To do this, the final filter must be removed.

Requirements

- The device is ready for operation (see "6 Startup", page 29).
- The device is now in dispensing mode.

NOTICE

Water leakage due to vessel overflow!

- ▶ Do **not** allow water to be dispensed unattended. The vessel being filled can overflow.
 - ▶ To avoid dispensing volumes that are too large: Volume-controlled dispensing of ultrapure water (see Chapter 7.2.3, page 46).
-

Procedure

- ▶ If dispensing is to take place via the final filter: Remove the protective cap from the final filter bell assembly.
- ▶ If dispensing is to take place via the outlet tubing:
 - ▶ Remove the final filter (see page 62).
 - ▶ Connect the outlet tubing (connection, see Chapter "6.8.2 Performing a Rinse Cycle," page 42).
- ▶ Place a suitable vessel under the water outlet.
- ▷ The device is ready to dispense ultrapure water.

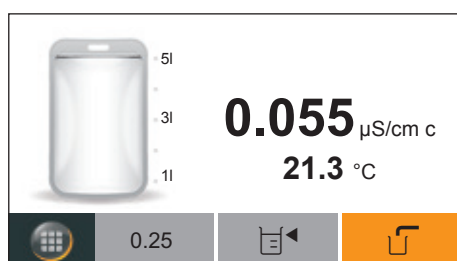

7.2.2 Manually Dispensing Ultrapure Water

During manual dispensing, ultrapure water is dispensed until stopped manually.

Only arium® mini plus or arium® mini: When the maximum filling level of the bag has been reached: Dispensing will end automatically.

Procedure

- ▶ Tap the [⏏] symbol.
- ▷ Dispensing begins. The volume dispensed thus far is displayed in increments of 0.05 liters (50 ml).
- ▷ The ultrapure water flows into the vessel at a maximum throughput rate of about 1.0 l/min.
- ▷ If an arium® mini plus or arium® mini is used: The filling level of the bag will be updated on the display during dispensing.

- ▶ To stop dispensing: Tap the [STOP] button.
- ▶ When dispensing is finished: Attach the protective cap to the final filter bell assembly.

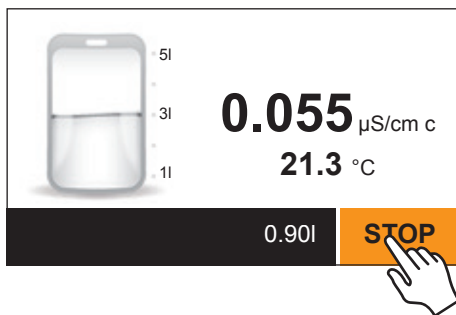
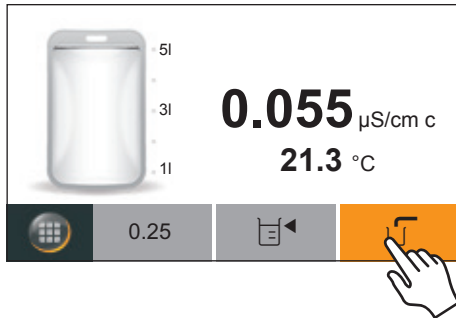

7.2.3 Volume-controlled Dispensing of Ultrapure Water

During volume-controlled water dispensing, a previously specified amount of water is dispensed. The volume to be dispensed must be entered with the following specifications:

- The minimum dispensing volume is 0.05 liters (50 ml).
- The maximum dispensing volume is 5.00 liters.
- Only volumes between 0.05 and 5.00 liters can be entered. Invalid numeric fields become inactive (white background).
- Only arium® mini plus or arium® mini: When a higher dispensing volume is entered than that in the bag, dispensing **cannot** be started. An appropriate message will be displayed.

Procedure

- ▶ Tap the [⏏] symbol.
- ▷ The numeric keypad for inputting volumes appears.

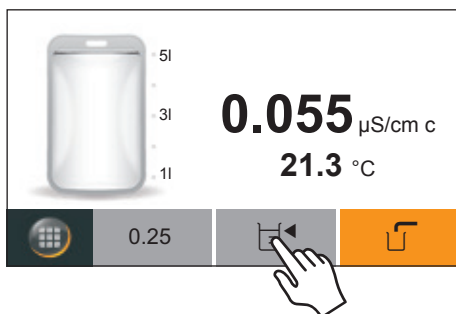

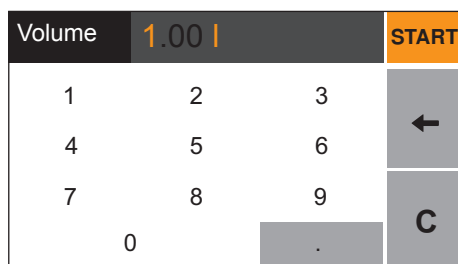

- ▶ Enter the desired dispensing volume in liters. Observe the guidelines for volume input.
- ▷ The volume entered appears.
- ▶ Tap the [START] button.
- ▷ Dispensing begins:
 - The volume dispensed thus far is displayed in increments of 0.05 liters (50 ml).
 - The ultrapure water flows into the vessel at a maximum throughput rate of about 1.0 l/min.
 - If an arium® mini plus or arium® mini is used: The filling level of the bag will be updated on the display during dispensing.
 - Dispensing will stop automatically when the selected dispensing volume has been reached.

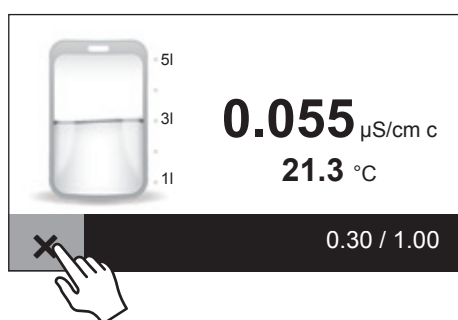

- ▶ To cancel dispensing before it is finished: Tap the [x] button.

Using Favorites

The last selected dispensing volume is automatically stored and displayed on the Favorites button on the dispensing screen.

Procedure

- ▶ To start another dispensing process with the previously selected dispensing volume: Tap the Favorites button.
- ▷ Dispensing begins.
- ▶ When dispensing is finished: Attach the protective cap to the final filter bell assembly.

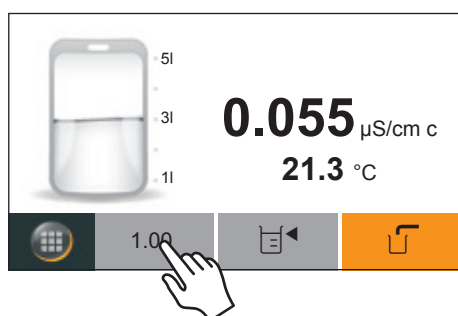

7.2.4 Confirming Dispensing Cancellation

Only as much water can be dispensed as is present in the bag.

arium® mini plus

If the bag contains an **insufficient** amount of water, dispensing stops and the dialog box "Dispense canceled" appears.

Procedure

- ▶ Confirm the message with the [✓] button.
- ▶ Wait until the bag has filled to a sufficient level.
- ▶ Restart dispensing.

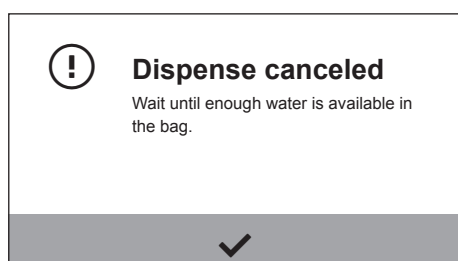

arium® mini

Procedure

- ▶ If the bag **no longer** contains sufficient water:
 - ▶ Manually fill the bag (see Chapter , page 48).
 - ▶ Continue dispensing.

7.2.5 Ending Dispensing via Outlet Tubing

Procedure

- ▶ Once dispensing via the outlet tubing is complete:
 - ▶ Disconnect outlet tubing from the device (disconnecting outlet tubing, see Chapter "6.8.2 Performing a Rinse Cycle," page 42).
 - ▶ Connect the final filter (see Chapter "6.9 Connecting the Final Filter," page 44).

7.2.6 Removing Pure Water from the Bag (only arium® mini plus or arium® mini)

Using the tank outlet tubing connected to "Bag Outlet", pure water can be manually dispensed directly from the bag. Dispensing takes place entirely without pressure.

Procedure

- ▶ Guide the tank outlet tubing into a suitable container.
- ▶ Open the ball cock of the tank outlet tubing.
- ▷ Pure water flows out of the bag.
- ▶ When dispensing is finished: Close the ball cock.

7.3 Opening the Menu

Procedure

- ▶ To open the menu: Tap the  button in dispensing mode. The following tasks can be carried out:

Possible device tasks	Chapter, page
Manually filling the bag (only arium® mini)	7.4, page 49
Activate or deactivate standby mode	7.5, page 50
Change system settings	7.6, page 51
Open the "Care" menu	8.3, page 54

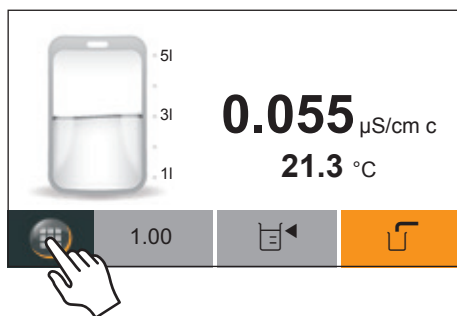

7.4 Manually Filling the Bag (only arium® mini)

If the bag filling level of the device has been reached or is **no longer** sufficient for the desired dispensing volume, the bag can be filled manually. Manual filling of the bag can be carried out in several ways.

7.4.1 Starting Manual Filling Using the Wizard

Procedure

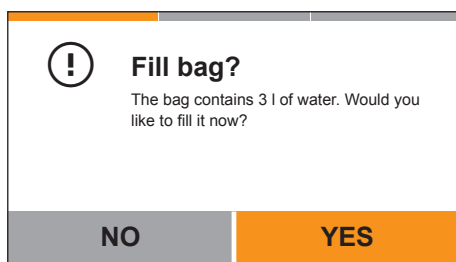

- ▶ If the filling level is too low for the dispensing volume entered during volume-controlled dispensing:
 - ▷ The dialog box "Fill bag?" appears.
 - ▶ Tap the [YES] button.

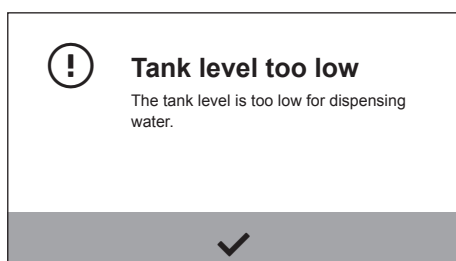

- ▷ The bag empties during manual dispensing.
- ▷ The message "Tank level too low" appears.
- ▶ Confirm the message with the [✓] button.
- ▷ [FILL BAG] appears on the dispensing screen.
- ▶ Tap the [START] button.

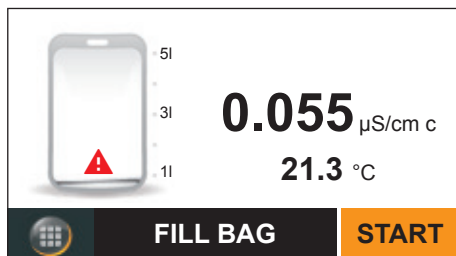

- ▶ If the bag is empty before dispensing, e.g. because ultrapure water was dispensed manually:
 - ▷ The message [FILL BAG] appears on the dispensing screen.
 - ▶ Tap the [START] button.

7.4.2 Starting Manual Filling in the Menu

If the bag contains water: Bag filling must be initiated using the menu. To do this:

Procedure

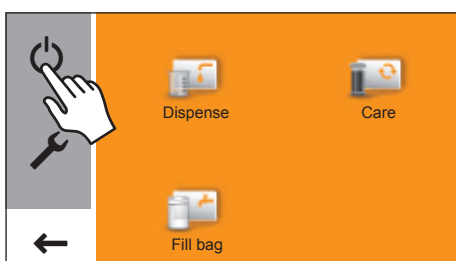

- ▶ Tap the  [Fill bag] symbol.

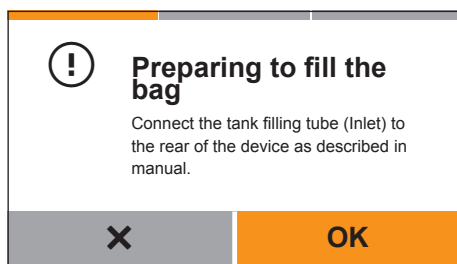

- ▷ The dialog box "Fill bag" (Step 1) appears.
- ▶ Check whether the tank filling tubing is connected to the "Inlet" connection.
 - ▶ If required: Connect the tank filling tubing.
- ▶ **NOTICE** Insufficient water quality possible due to contaminated tank filling tubing! Check the tank filling tubing for contamination.
 - ▶ If required: Change tank filling tubing and bag.
- ▶ Tap the [OK] button.

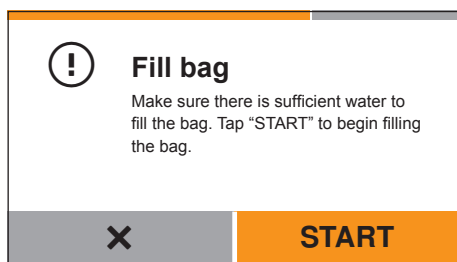

- ▷ The dialog box "Fill bag" (Step 2) appears.
- ▶ **NOTICE** Device functions can be impaired by air intake! If there is **insufficient** water during the filling process: Air is drawn into the system. The air in the system can impair correct functioning of the device. Prepare a vessel with pretreated water (at least 5 liters).
- ▶ Place the tank filling tubing into the container and secure it so that its opening is completely submerged during filling.
- ▶ Tap the [START] button.

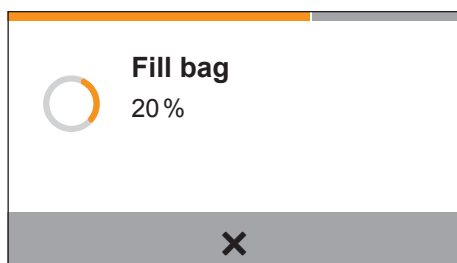

- ▷ The bag is filled with water. Progress is displayed as a percentage.
- ▶ **NOTICE** Device functions can be impaired by air intake! If there is **insufficient** water during the filling process: Air is drawn into the system. The air in the system can impair correct functioning of the device.
 - ▶ If there is **insufficient** water in the container: Cancel the filling process prematurely and fill the container with pretreated water.
- ▶ To cancel the filling process prematurely:
 - ▶ Tap the [x] button.
- ▷ The dialog box "Fill bag" (Step 2) appears.
- ▶ Carry out filling as described above again.

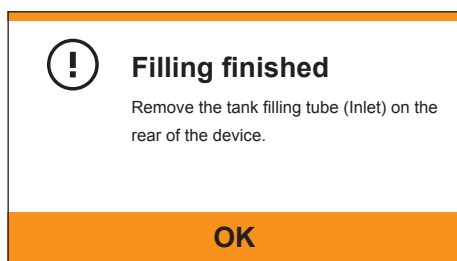

- ▷ When filling is complete, the dialog box "Filling finished" appears.
- ▶ Check that the free end of the tank filling tubing is secured.
 - ▶ If required: Remove the tank filling tubing from the "Inlet" connection at the rear of the device and keep it in a safe place.
- ▶ Confirm the bag filling process with the [OK] button.
- ▷ The display changes to the dispensing screen.

7.5 Activating or Deactivating Standby Mode

If **no** water is dispensed for a long time, the device automatically switches to standby mode. This ensures more economical and ecological operation. In standby mode, the pre-stage is **no longer** active and ultrapure water is no longer in circulation. Standby mode can also be activated manually.

If the device is manually switched into standby mode while the bag is being automatically filled, a prompt for further action appears. The filling of the bag can be canceled immediately, which puts the device in standby mode. If filling is continued, the device will automatically switch to standby mode.

7.5.1 Automatic ECO Mode

In addition to standby mode, the device also features an ECO function. One minute after the last operation, recirculation of ultrapure water is stopped and the display darkens. After another 15 minutes without touching the display, the device automatically switches to standby mode.

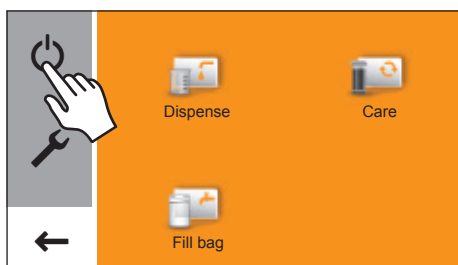

Procedure

- ▶ To activate standby mode: Tap the [⏻] button.
- ▶ The display darkens. The [⏻] button remains visibly backlit.



- ▶ To deactivate standby mode: Tap the [⏻] button.
- ▶ The start screen appears. When system startup is complete, the display returns to the dispensing screen.

7.6 Changing System Settings

The system settings for the device, e.g. date, time, displayed values, can be changed in the "Settings" menu.

Procedure

- ▶ Tap the [🔧] button.

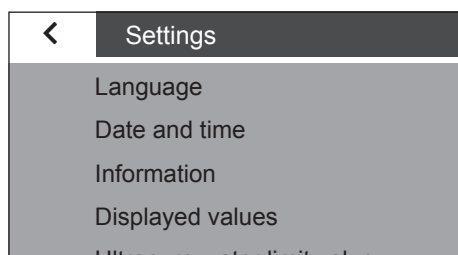

- ▶ The "Settings" menu appears.
- ▶ Configure desired settings (possible settings, see parameter list Chapter "4.9 Parameters of the "Settings" Menu," page 25).

7.7 Performing Volume Adjustment

To dispense the most accurate amount of ultrapure water, the flow rate sensor of the device can be readjusted.

For this purpose, a sample volume of approximately one half liter is dispensed. The actual volume of the extracted sample volume is measured and transmitted to the device. This sample volume is used as a reference for the volume dispense function.

Procedure

- ▶ Tap the menu item [Volume adjustment].
- ▷ The dialog box "Volume adjustment" appears.
- ▶ Place a graduated measuring cup or graduated cylinder with a capacity of at least 1 liter under the water outlet.
- ▶ Tap the [START] button.

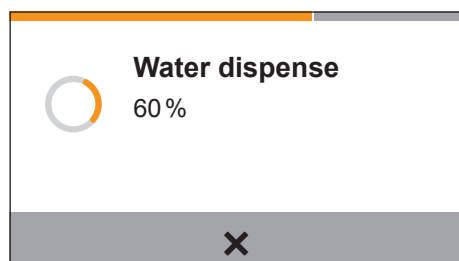
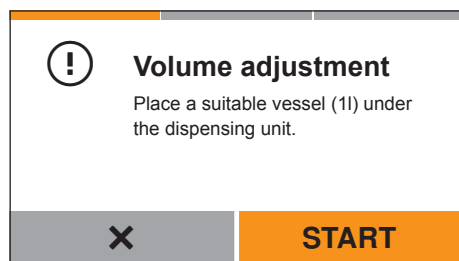

- ▷ The dialog box "Water dispense" appears. Dispensing progress is displayed as a percentage.
- ▷ When 100% is reached, dispensing will stop automatically.

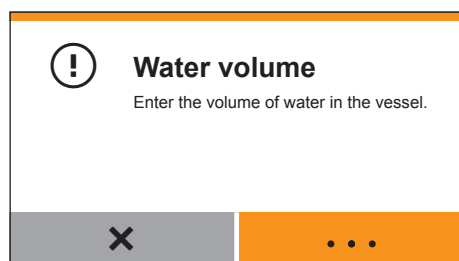

- ▷ The dialog box "Water volume" appears.

Use the Weight of the Sample Volume to Determine the Volume

If **no** graduated measuring cup or graduated cylinder is available, the weight of the sample volume can be used as an alternative for determination of the actual volume.

Procedure

- ▶ Determine the weight of the sample volume.
- ▶ Convert the weight of the sample volume into a liter value.
- ▶ Enter the value into the device in liters.
- ▶ To enter the actual volume dispensed:
 - ▶ Tap the [...] button.
 - ▶ Read and enter the value for the sample volume in liters.
- ▷ The dialog box "Adjustment finished" appears.
- ▶ Confirm the procedure with the [✓] button.

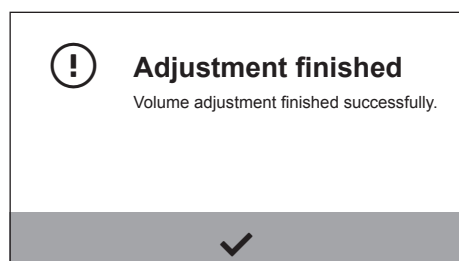

8 Cleaning and Maintenance

8.1 Cleaning

8.1.1 Cleaning the Display

Procedure

- ▶ To **avoid** uncontrolled changes to the settings of the device: Activate standby mode (see Chapter 7.5, page 50).
- ▶ Wipe the display gently with a soft, dry cloth.
- ▶ Deactivate standby mode (see Chapter 7.5, page 50).

8.1.2 Cleaning the Device Housing

CAUTION

Danger of injury caused by electric current!

When cleaning the device and its components while they are connected to the power supply, there is a risk of electric shock.

- ▶ Always disconnect the device from the AC power before cleaning.
-

NOTICE

The electronic equipment could be damaged by improper cleaning!

Liquids or dust can damage the device or the power supply.

- ▶ **Never** open the power supply or the right side of the device housing.
 - ▶ Make sure that **no** liquids or dust get into the device or the AC adapter.
-

NOTICE

Damage to the device surfaces!

Aggressive cleaning agents may damage device surfaces.

- ▶ Never use cleaning agents that contain solvents, acetone or abrasive ingredients.
-

Procedure

- ▶ Disconnect the device from the power supply.
- ▶ Wipe the housing of the device with a damp cloth.
- ▶ If installed components must be cleaned: Remove the front cover and the left side cover and wipe down the installed components with a damp cloth.
- ▶ Dry the device with a soft cloth.

8.2 Maintenance Schedule

Depending on the volume of water dispensed, it may be necessary to change the consumables more often than specified in the maintenance schedule. If, for example, sterile water is required, the final filter must be replaced regularly.

It is advisable to replace different consumables in the same maintenance step. This saves time and water. We recommend that you make a sensible plan for replacing consumables.

Interval	Component	Task	Chapter, page
12 months	UV lamp (optional)	Changing the UV Bulb	8.5.3, page 58
Max. 6 months (depending on the volume of water dispensed)	Ultrapure water cartridge (Scientific Pack)	Replace ultrapure water cartridge	8.5.4, page 59
6 months (only arium® mini plus or arium® mini)	Bag	Replacing the Bag	8.5.2, page 56
6 months (only arium® mini plus)	Pretreatment cartridge	Replace the pretreatment cartridge	8.5.3, page 58
1 – 24 weeks (depending on the application)	Sterile filter (final filter)	Change final filter	8.5.6, page 62
1 – 13 weeks (depending on the application)	Ultrafilter (final filter)	Change final filter	8.5.6, page 62

8.3 Opening the "Care" Menu

The "Care" menu contains all the steps for the care and maintenance work.

Procedure

- ▶ Tap the  [Care] symbol in the menu.

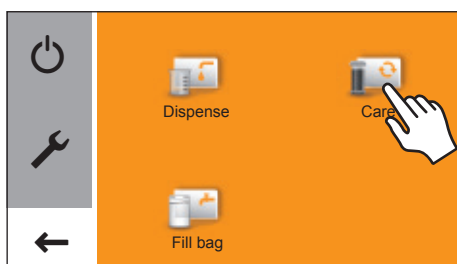

- ▷ The "Care" menu appears. The following tasks can be carried out.

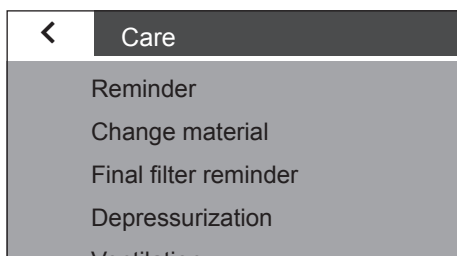

Possible device tasks	Chapter, page
Display reminders	8.4, page 55
Replace consumables	8.5, page 55
Enable, disable or configure reminders for replacing final filters	8.6, page 63
Manual depressurization	8.7, page 63
Carry out venting	8.8, page 64

8.4 Displaying Reminders

Reminders to replace certain consumables are automatically displayed as warning messages (see Chapter 9.2, page 68). Pending consumables replacements can be viewed at a glance.

All reminders are automatically updated after the consumable has been replaced.

Procedure

- ▶ Tap the menu item [Reminder] in the "Care" menu.
- ▷ The date for the next required replacement is displayed for the bag, the pretreatment and ultrapure water cartridge, the UV lamp and the final filter.

Reminder		✓
Bag:	01.07.2016	
Pretreatment cartridge:	01.07.2016	
Ultrapure water cartridge:	01.07.2016	
UV lamp:	01.02.2017	
Sterile final filter:	01.04.2016	

8.5 Replacing Consumables

8.5.1 Selecting Consumables for Replacement

Consumable replacement must be set using the display. To do this, you must define which consumables are to be replaced in the menu "Replace consumable". 1 or more consumables can be selected.

If several consumables are selected: The wizard guides you through the replacement of the individual consumables. The individual steps are shown on the display.

Procedure

- ▶ Tap the menu item [Change material] in the "Care" menu.
- ▷ The "Change material" menu appears. The consumables that can be changed are indicated, e.g. bag, pretreatment cartridge.

Change material		✗
Bag		
Pretreatment cartridge		
Ultrapure water cartridge		
UV lamp		
Sterile filter		

Change material		✓
✓ Bag		
✓ Pretreatment cartridge		
✓ Ultrapure water cartridge		
UV lamp		
Sterile filter		

- ▶ Select the desired consumables. To do this, tap on the menu items for the consumables, e.g. [Bag], [Pretreatment cartridge] and [Ultrapure water cartridge].
- ▷ The selected menu items are highlighted and marked with a checkmark.
- ▶ Confirm the selection of consumables with the [✓] button.
- ▷ If several consumables are selected: The wizard guides you through all consumable replacement and work steps.

8.5.2 Replacing Bag (only arium® mini plus or arium® mini)

Draining the Bag

Requirements

- In the "Change material" menu, the menu item [Bag] is activated.
- The "Empty bag" dialog box appears.

Procedure

- ▶ Check whether the tank outlet tubing is connected to the "Bag Outlet" connection.
 - ▶ If required: Connect the tank outlet tubing.
- ▶ Guide the tank outlet tubing into a suitable container.
- ▶ In order to empty the bag completely: Place the container underneath the device.
- ▶ Open the ball cock of the tank outlet tubing.
- ▷ Pure water flows out of the bag.
- ▶ When the bag is empty: Confirm the emptying of the bag with the [OK] button.
- ▷ The dialog box "Change bag" appears.

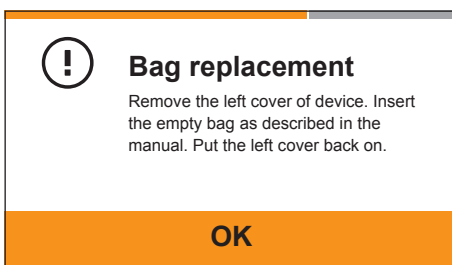
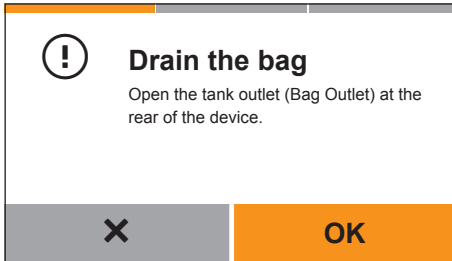

Removing Empty Bag

Procedure

- ▶ Remove the left side cover:
 - ▶ Reach behind the side cover and pull the side cover to the side (1).
 - ▶ Pull the side cover up and off to remove it (2).



- ▶ To make it easier to reach the lower connections on the device: Pull the tray up and remove it from the device.
- ▶ Disconnect the gray quick connector on the three device connections successively.
- ▶ Slide the empty bag out of the guide rail and remove it from the device.



Inserting New Bag

Procedure



- ▶ **NOTICE** Danger of damage to the device from improper handling! The bag may be damaged if forced into the guide rails: The bag can be damaged. Use only slight pressure when inserting the bag into the guide rail.
- ▶ Using the handle, slide the bag into the guide rail in the upper portion of the device housing. The bag is secure when the reinforcing piece on the carrying handle is completely engaged in the guide rail.



- ▶ Using the quick connector, fasten the upper hose of the bag to the device's upper connection.
- ▷ The quick connector locks into place with an audible click.
- ▶ Fasten the two lower bag hoses to the lower device connections using the quick connectors.
- ▷ The quick connectors lock into place with an audible click.

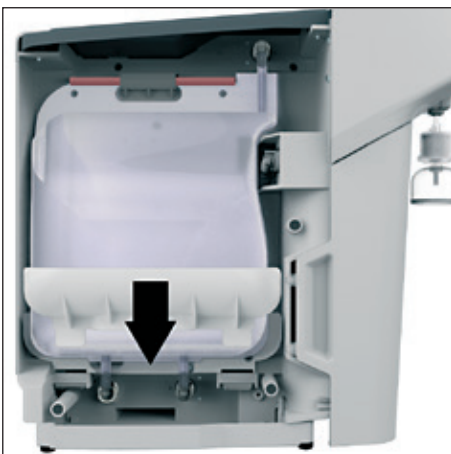

- ▶ Reinsert the tray. Make sure **not** to damage the bag.
- ▶ Reattach the left side cover of the device.
- ▶ Confirm the insertion of the bag with the [OK] button.



Close bag outlet

Close the tank outlet (Bag Outlet) at the rear of the device.

OK

- ▷ The dialog box "Close tank outlet" appears.
- ▶ Close the ball cock of the tank outlet tubing.
- ▶ Confirm that the tank outlet has been closed with the [OK] button.
- ▷ If an arium® mini plus is used: The device automatically begins filling the bag.
- ▶ If an arium® mini is used: The filling process must be started.
 - ▷ The dialog box "Fill bag?" appears on the device display.
 - ▶ To fill the bag: Tap the [YES] button. Manually fill the bag (see Chapter 7.2.5, page 48).
 - ▶ To fill the bag at a later point in time: Tap the [NO] button.

8.5.3 Replacing Pretreatment Cartridge (only arium® mini plus)

To replace pretreatment cartridges, the final filter must be removed and the device depressurized. The pretreatment cartridge is marked with an "R".

Requirements

- In the "Change material" menu, the menu item [Pretreatment cartridge] is activated.
- The dialog box "Remove filter" appears.

Procedure

- ▶ Remove the final filter (removal, see Chapter "8.5.6 Changing Final Filter," page 62).
- ▷ The dialog box "Prepare depress. / Start depressurization" appears.
- ▶ Start depressurization (see Chapter 8.7, page 63).
- ▷ When depressurization is complete, the dialog box "Remove cover" appears.
- ▶ Remove the front cover.
- ▶ Confirm removal of the cover with the [OK] button.

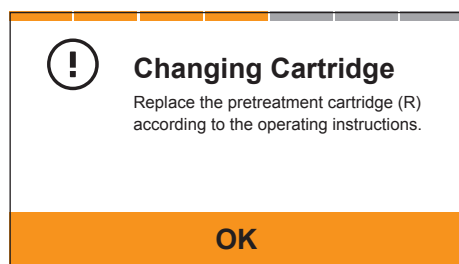
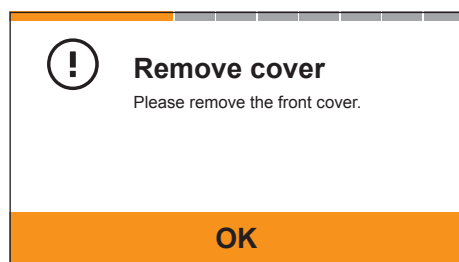

- ▷ The dialog box "Change cartridge" appears. The pretreatment cartridge (R) can be changed.



- ▶ Press the two protruding clamps of the pretreatment cartridge together and pull the pretreatment cartridge forward and out.
- ▶ Confirm removal of the pretreatment cartridge with the [OK] button.
- ▶ Insert a new pretreatment cartridge in the device (see Chapter 6.3, page 34).
- ▶ Rinse the pretreatment cartridge (see Chapter 6.7, page 40).
- ▷ Once the pretreatment cartridge has been rinsed:
 - The dialog box "Connect filter" appears.
- ▶ Connect the final filter (see Chapter 6.9, page 44).
- ▷ Replacing the pretreatment cartridge is complete.

8.5.4 Replacing Ultrapure Water Cartridge

To replace the ultrapure water cartridge, the final filter must be removed and the device depressurized. The ultrapure water cartridge is marked with an "L".

Requirements

- In the "Change consumable" menu, the menu item [Ultrapure water cartridge] is activated.
- The dialog box "Remove filter" appears.

Procedure

- ▶ Remove the final filter (removal, see Chapter "8.5.6 Changing Final Filter," page 62).
- ▷ The dialog box "Prepare depress. / Start depressurization" appears.
- ▶ Start depressurization (see Chapter 8.7, page 63).
- ▷ When depressurization is complete, the dialog box "Remove cover" appears.
- ▶ Remove the front cover.
- ▶ Confirm removal of the cover with the [OK] button.

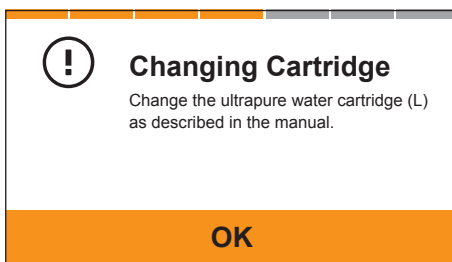
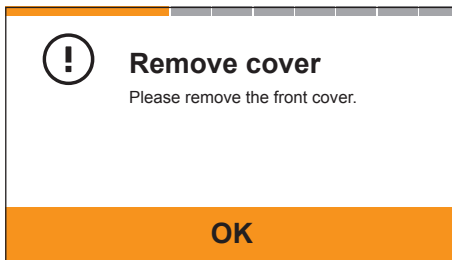

- ▷ The dialog box "Change cartridge" appears. The ultrapure water cartridge (L) can be changed.



- ▶ Press the two protruding terminals of the ultrapure water cartridge together and pull the ultrapure water cartridge forward and out.
- ▶ Confirm removal of the ultrapure water cartridge with the [OK] button.
- ▶ Insert a new ultrapure water cartridge in the device (see Chapter 6.4, page 35).
- ▶ Rinse the ultrapure water cartridge (see Chapter 6.8, page 41).
- ▷ Once the ultrapure water cartridge has been rinsed: The dialog box "Connect filter" appears.
- ▶ Connect the final filter (see Chapter 6.9, page 44).
- ▷ Replacing the ultrapure water cartridge is complete.

8.5.5 Replacing the UV Lamp

The device can be equipped with a UV lamp. When replacing the UV lamp: A suitable UV lamp must be used (suitability, see Chapter "15 Consumables," page 77).

The UV lamp is installed under the right-side cartridge holder (pretreatment cartridge). The pretreatment cartridge is marked with an "R".

To change the UV lamp, the final filter must be removed and the device depressurized.

If an arium® mini plus is used: The pretreatment cartridge must be removed to reach the UV lamp behind it.

Requirements

- In the "Change material" menu, the menu item [UV lamp] is activated.
- The dialog box "Remove filter" appears.

Procedure

- ▶ Remove the final filter (removal, see Chapter "8.5.6 Changing Final Filter," page 62).
- ▷ The dialog box "Prepare depress. / Start depressurization" appears.
- ▶ Start depressurization (see Chapter 8.7, page 63).
- ▷ When depressurization is complete, the dialog box "Remove cover" appears.
- ▶ Remove the front cover.
- ▶ Confirm removal of the cover with the [OK] button.
- ▶ If an arium® mini plus is used:
 - ▷ The "Remove the pretreatment cartridge (R) as described in the manual" dialog box appears.
 - ▶ Remove the pretreatment cartridge (see Chapter 8.5.3, page 58).

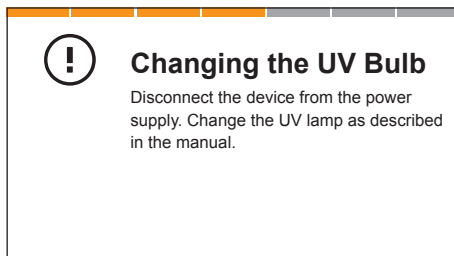
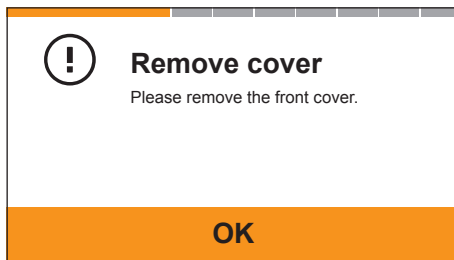

- ▷ The dialog box "Change UV lamp" appears.

Removing the UV Lamp

⚠ CAUTION

Risk of injury from electrical current and UV radiation!

The UV lamp emits UV radiation and may be live.

- ▶ Disconnect the device from the power supply before the old UV lamp is removed.

Procedure

- ▶ Disconnect the device from the power supply.
- ▷ The display goes out. After the power has been restored, the wizard will continue automatically.
- ▶ Squeeze the metal retaining clip on the old UV lamp and pull it forward to remove it.
- ▶ Remove the metal retaining clip from the cable and store it in a safe place, e.g. on the magnet securing the cover.





- ▶ Disconnect the black connector from the old UV lamp.
- ▶ Unscrew the black plastic cover of the UV lamp housing. If required: Use a suitable tool to help you do this.

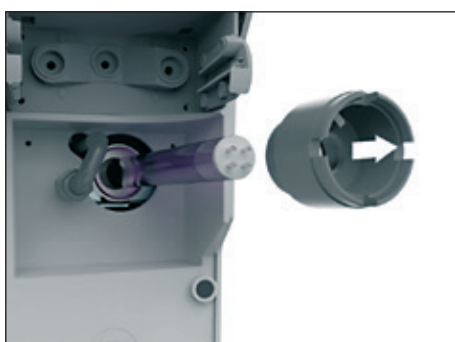

- ▶ Remove the black plastic cover of the UV lamp housing.
- ▶ Carefully pull the old UV lamp out of the lamp housing, package it and safely dispose of it (see Chapter "13 Disposal," page 71).

Inserting the UV Lamp

NOTICE

Touching UV lamps with your bare fingers will cause them to become defective!

Touching the UV lamp with your bare fingers will leave fingerprints. The fingerprints can become so hot during operation that the UV lamp is destroyed.

- ▶ **Never** touch the glass of the UV lamp with your bare fingers.
- ▶ Only hold the UV lamp where it connects to the device or when wearing gloves.

Procedure

- ▶ Carefully unpack the new UV lamp without touching the glass with your fingers.
- ▶ Insert the new UV lamp all the way into the lamp housing without exerting pressure on it.
- ▶ Unscrew the black plastic cover of the UV lamp housing by hand.
- ▶ Attach the black connector to the UV lamp. The connector only fits in two orientations. Both orientations allow the UV lamp to function.
- ▶ Slide any protruding cable back into the housing.
- ▶ Slide the metal retaining clip over the cable and onto the black plastic cover of the UV lamp housing.
- ▶ Insert the closed side of the metal retaining clip into the recess of the black plastic cover provided.
- ▶ Squeeze the open side of the metal retaining clip and insert it into the recesses provided in the black plastic cover.
- ▶ Release the metal retaining clip secures it to the black plastic cover.
- ▶ Connect the device to the power supply.
- ▶ The wizard continues.
- ▶ Follow the instructions on the display, e.g. "Insert the new pretreatment cartridge (R) as described in the manual".

8.5.6 Changing Final Filter

Remove final filter

Requirements

- If the menu items [Final filter] or [Ultrafilter] are activated in the "Replace consumable" menu: The dialog box "Remove filter" appears.
- If the menu items [pretreatment cartridge], [ultrapure water cartridge] or [UV lamp] are activated in the "Replace consumable" menu: The dialog box "Remove filter" appears.

Procedure

- ▶ Use the tubing removal tool to push and hold the water outlet quick connector up.
- ▷ The quick connector is unlocked.
- ▶ Pull the final filter out of the quick connector.
- ▶ Confirm removal of the final filter with the [OK] button.

Connect new final filter

Requirements

- The final filter has been removed.
- The dialog box "Connect filter" appears.

Procedure

- ▷ Connect and rinse a new final filter (see Chapter 6.9, page 44 and Chapter 6.10, page 44).

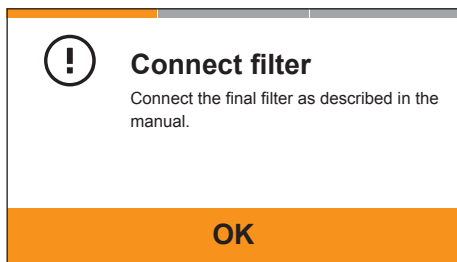
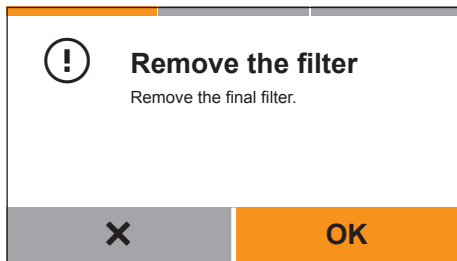

8.6 Enabling, Disabling or Configuring Reminders for Replacing Final Filters

If sterile or endotoxin-free water is constantly required, the final filter must be replaced regularly. The device can provide a reminder about a pending final filter replacement.

Procedure

- ▶ Tap the menu item [Final filter reminder] in the "Care" menu.
- ▷ The dialog box "Final filter reminder" appears.
- ▶ Tap the [Active] button.
- ▷ Select the installed final filter, e.g. [sterile filter] or [ultrafilter].
- ▷ The currently configured replacement interval appears in the column "Reminder [weeks]".
- ▶ To change the replacement interval: Tap the [...] button.
- ▷ The numeric keypad appears.
- ▶ Type the desired replacement interval (in weeks) (required maintenance intervals, see Chapter "8.2 Maintenance Schedule," page 54)
- ▶ Confirm the entry with the [✓] button.
- ▶ To activate the reminder: In the dialog box "Final filter reminder", press the [✓] button.
- ▶ If **no** sterile or endotoxin-free water is required:
 - ▶ Remove the final filter (see Chapter 8.5.3, page 58).
 - ▶ To deactivate reminders about replacing the final filter: In the dialog box "Final filter reminder", press the [Inactive] button.

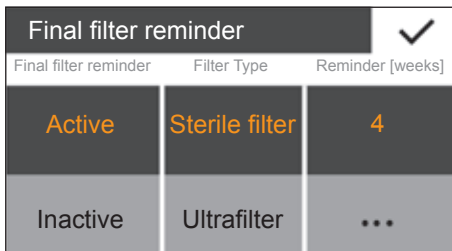

8.7 Carrying Out Depressurization

The device is under pressure during operation. If the device is taken out of service for an extended period of time or permanently, the pressure in the device must be let out manually.

Procedure

- ▶ Tap the menu item [Depressurize] in the "Care" menu.
- ▷ The dialog box "Remove filter" appears.
- ▶ Remove final filter (see Chapter 8.5.3, page 58).
- ▶ Confirm removal of the final filter with the [OK] button.

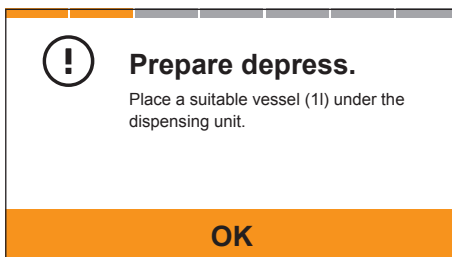
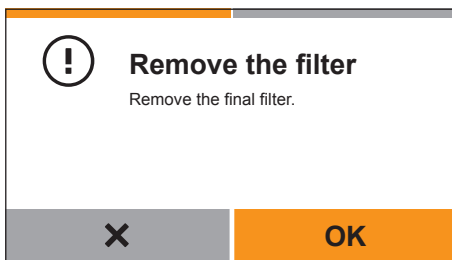

- ▷ The dialog box "Prepare depress." appears.
- ▶ Place a vessel (at least 1 liter) under the water outlet. Alternatively, connect the dispense tube and run the free end to the drain.
- ▶ Confirm this preparatory step with the [OK] button.

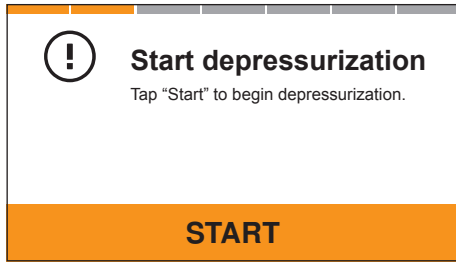

- ▷ That dialog box "Start depressurization" appears.
- ▶ Tap the [START] button.

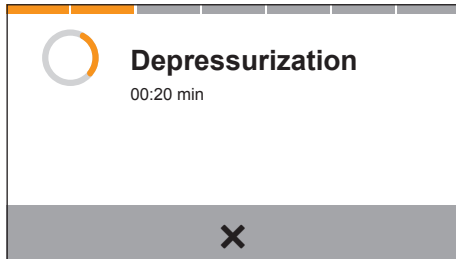

- ▷ The dialog box "Depressurization" appears.
- ▷ The device depressurizes. The process takes about half a minute.
- ▶ To cancel the depressurization process before it is finished, e.g. if a sufficiently large vessel is **unavailable**: Tap the [x] button.
- ▷ That dialog box "Start depressurization" appears again.
- ▶ Carry out depressurization as described above again.

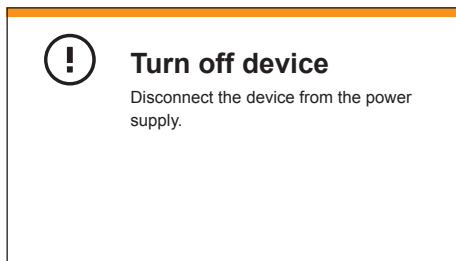

- ▷ When depressurization is complete, the dialog box "Turn off device" appears.
- ▶ Disconnect the device from the power supply.
- ▶ Pressurization is carried out when the device is switched on again.

8.8 Carrying Out Venting

During venting, the device fills and rinses the ultrapure water cartridge. Air is removed from the ultrapure water circulation in the process.

Given the following conditions: The ultrapure water circuit must be purged:

- The displayed water quality is fluctuating continuously during operation.
- The device was taken out of service for an extended period.

Procedure

- ▶ Tap the menu item [Venting] in the "Care" menu.
- ▷ The dialog box "Remove filter" appears.
- ▶ Remove the final filter (see Chapter 8.5.3, page 58).
- ▶ Confirm removal of the final filter with the [OK] button.

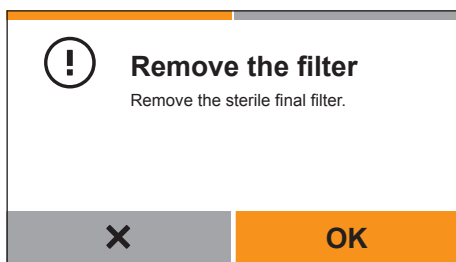

- ▷ The dialog box "Prepare rinsing" appears.
- ▶ Place a vessel (at least 1 liter) under the water outlet. Alternatively, connect the dispense tube and run the free end to the drain.
- ▶ Tap the [OK] button.

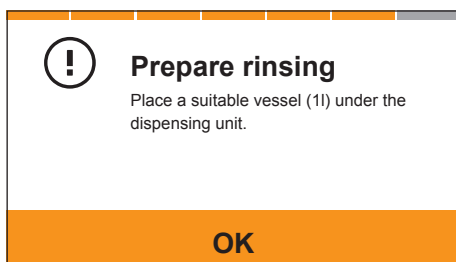

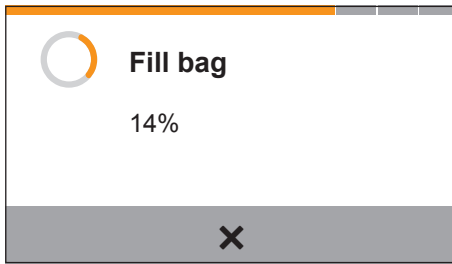

- ▶ arium® mini plus product water quality:
 - ▷ If the bag **no longer** contains a sufficient amount of water or empties during the rinsing process, the bag is filled automatically.
 - ▶ When filling is complete, the dialog box "Preparing to rinse" appears: Start the rinsing process again.

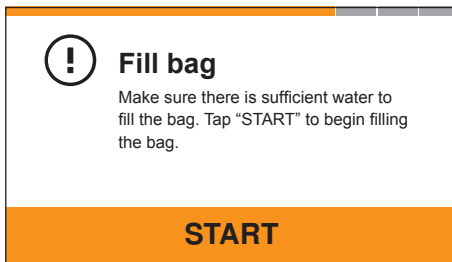

- ▶ Only arium® mini:
 - ▷ If the bag in the **no longer** contains a sufficient amount of water or empties during the rinsing process, the dialog box "Fill bag" appears.
 - ▶ The dialog box "Fill bag" appears: Manually fill the bag (see Chapter 7.2.5, page 48).

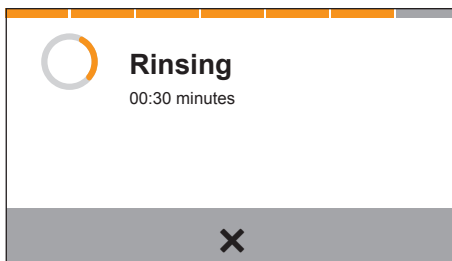

- ▷ During the rinse cycle, the remaining rinse time is displayed in minutes.
- ▶ To interrupt the rinse cycle:
 - ▶ Tap the [x] button.
 - ▷ The dialog box "Start rinsing" appears again.
- ▶ To resume the rinse cycle after an interruption: Tap the [START] button.

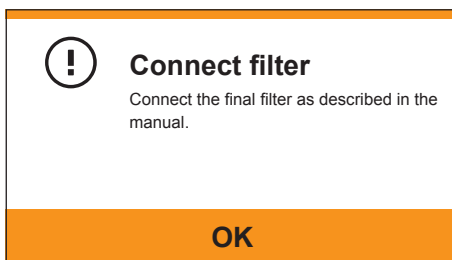

- ▷ When rinsing is complete, the dialog box "Connect filter" appears.
- ▶ Connect the final filter (see Chapter 6.9, page 44).
- ▶ Confirm that the final filter has been connected with the [OK] button.
- ▷ The display changes to the dispensing screen.

9 Malfunctions

9.1 Error Messages

If an error message is active, dispensing is canceled and locked automatically.

Error message	Fault	Cause	Correction	Chapter, page
Error 0105	Measured values are not being displayed.	There is an internal communications error.	Disconnect the device from the AC power and wait a minute. Reconnect the device to the AC power. If the error persists: Contact Sartorius Service.	7.1, page 45
Error 0140 Check UV lamp, replacement may be needed.	The UV lamp is not recognized.	The UV lamp is not connected properly or defective.	Check whether the black plug of the UV lamp is connected correctly. Remove the UV lamp and check for damage. If required: Change the UV lamp. If the error persists: Contact Sartorius Service.	8.5.5, page 60 8.5.5, page 60
Error 0150 Check device for leakage. Please contact your service technician.	The device has a leak.	Water has leaked inside the device.	Remove the left side cover and check that the three bag hoses are properly connected to the device connectors. If required: Remove the bag and reconnect it. Drain the tray at the bottom of the device and check that the connections are tight during operation. If the error persists: Contact Sartorius Service.	8.5.2, page 56
Error 0160 Front cover is open. Please put the front cover back on.	Operation of the device is not possible.	The front cover is not properly attached.	Correctly attach the front cover to the device. If the error persists: Contact Sartorius Service.	
Error 0163 Check proper fit of the pretreatment cartridge (R).	The pretreatment cartridge is not recognized.	The pretreatment cartridge has not been properly inserted.	Press the pretreatment cartridge in firmly until you hear a distinct clicking sound. If the error persists: – Remove the pretreatment cartridge. – Insert the pretreatment cartridge. If the error persists: Contact Sartorius Service.	8.5.3, page 58
Error 0166 Check proper fit of the ultrapure water cartridge (L).	The ultrapure water cartridge is not detected.	The ultrapure water cartridge has not been properly inserted.	Press the ultrapure water cartridge in firmly until you hear a distinct clicking sound. If the error persists: – Remove the ultrapure water cartridge. – Insert the ultrapure water cartridge. If the error persists: Contact Sartorius Service.	8.5.4, page 59

Error message	Fault	Cause	Correction	Chapter, page
Error 0180 Please contact your service technician.	The fill level of the bag is not being properly detected.	The bag is damaged or improperly connected.	Remove the left side cover and check the bag for damage. If required: Change bag.	8.5.2, page 56
			Check that the three bag hoses are properly connected to the device connectors. If required: Remove the bag and reconnect it.	8.5.2, page 56
		The sensor is defective.	Using the tank outlet tubing connected to "Bag Outlet", let about ¼ liters of pure water out of the bag and check the level change. If the error persists: Contact Sartorius Service.	7.2.6, page 48
Error The conductivity of the ultrapure water is outside of the measuring range.	The conductivity of the ultrapure water is outside of the measuring range.	There is air in the ultrapure water circulation.	Initiate venting.	8.8, page 64
		The ultrapure water cartridge has been used up.	Replace the ultrapure water cartridge. To dispense water for testing purposes: Disable the dispensing lock. If the error persists: Contact Sartorius Service.	8.5.4, page 59
Error The temperature of the ultrapure water is outside of measuring range.	The temperature of the ultrapure water is outside of measuring range.	The temperature of the ultrapure water is outside of measuring range.	Check whether the ambient temperature complies with the device specifications in the technical data. Dispense about 1 liter: – To dispense water for testing purposes: Disable the dispensing lock. – Dispense and discard about 1 liter of water. If the error persists: Contact Sartorius Service.	14.2, page 73
Error Ultrapure water quality > XX µS/cm	The limit has been exceeded and the dispensing lock is preventing further dispensing.	There is air in the ultrapure water circulation.	Perform venting. Replace the ultrapure water cartridge. To dispense water for testing purposes: Disable the dispensing lock. If the error persists: Contact Sartorius Service.	8.9, page 63 8.6.3, page 63
		The limit has been configured incorrectly.	Check the limit. If required: Configure the limit.	

9.2 Warning Messages

If a warning message is active, water can still be dispensed. The water quality is impaired under certain circumstances.

Warning message	Fault	Cause	Correction	Chapter, page
The conductivity measurement of the RO water is out of range.	The conductivity of the pure water cannot be determined.	The quality of the feed water is insufficient .	Check whether the quality of the feed water complies with the device specifications in the technical data.	14.6, page 75
		The pretreatment cartridge has been used up.	Replace the pretreatment cartridge. If the error persists: Contact Sartorius Service.	8.5.3, page 58
The conductivity of the ultrapure water is outside of the measuring range.	The conductivity of the ultrapure water cannot be determined.	There is air in the ultrapure water circulation.	Perform venting.	8.8, page 64
		The ultrapure water cartridge has been used up.	Replace the ultrapure water cartridge. If the error persists: Contact Sartorius Service.	8.5.4, page 59
Temperature measurement of the RO water is out of range.	The temperature of the pure water cannot be determined.	The temperature of the pure water is outside of measuring range.	Check whether the temperature of the feed water complies with the device specifications in the technical data.	14.6, page 75
			Check whether the ambient temperature complies with the device specifications in the technical data. If the error persists: Contact Sartorius Service.	14.2, page 73
The temperature of the ultrapure water is outside of measuring range.	The temperature of the ultrapure water cannot be determined.	The temperature of the ultrapure water is outside of measuring range.	Check whether the ambient temperature complies with the device specifications in the technical data.	14.2, page 73
			Dispense and discard about 1 liter of water. If the error persists: Contact Sartorius Service.	
RO water quality > XX µS/cm	The limit has been exceeded.	The quality of the pure water is insufficient .	Check whether the quality of the feed water complies with the device specifications in the technical data.	14.6, page 75
		The pretreatment cartridge has been used up.	Replace the pretreatment cartridge.	8.5.3, page 58
Ultrapure water quality > XX µS/cm	The limit has been exceeded.	There is air in the ultrapure water circulation.	Perform venting.	8.8, page 64
		The limit has been configured incorrectly.	Replace the ultrapure water cartridge. Check the limit. If required: Configure the limit.	8.5.4, page 59
RO water temperature > XX °C	The limit has been exceeded.	The temperature of the feed water is too high or too low.	Check whether the temperature of the feed water complies with the device specifications in the technical data.	14.6, page 75
Ultrapure water temperature > XX °C	The limit has been exceeded.	The ambient temperature of the device is too high or too low.	Check whether the ambient temperature complies with the device specifications in the technical data. Dispense and discard about 1 liter of water.	14.2, page 73

Warning message	Fault	Cause	Correction	Chapter, page
Replacement of the pretreatment cartridge (R) is required.	The pretreatment cartridge needs to be replaced.	The replacement interval of the pretreatment cartridge has expired.	Replace the pretreatment cartridge.	8.5.3, page 58
Replacement of the ultrapure water cartridge (L) is required.	The ultrapure water cartridge needs to be replaced.	The replacement interval of the ultrapure water cartridge has expired.	Replace the ultrapure water cartridge.	8.5.4, page 59
Replacement of the bag is required.	The bag needs to be replaced.	The replacement interval of the bag has expired.	Replace the bag.	8.5.2, page 56
Replacement of the UV lamp is required.	The UV lamp needs to be replaced.	The replacement interval of the UV lamp has expired.	Change UV lamp.	8.5.5, page 60
Replacement of the sterile final filter is required.	The sterile final filter needs to be replaced.	The replacement interval of the sterile final filter has expired.	Replace the final filter.	8.5.3, page 58
Sartorius maintenance is required.	Maintenance service must be performed.	The maintenance service interval has expired.	Contact Sartorius Service.	

9.3 Additional Faults

Fault	Cause	Correction	Chapter, page
The device unexpectedly stops dispensing.	The bag is empty.	Check the level of the bag on the display.	
		Remove the left cover and check the fill level of the bag. If required: Manually fill the bag (only arium® mini).	7.3, page 48
		Check that the feed water tubing has been correctly connected.	6.6.1, page 38
		There is no feed water is connected.	Connect the feed water tubing or tank filling tubing.
The final filter is clogged or contains air.		If the final filter is attached and no water can be dispensed:	6.10, page 44
		<ul style="list-style-type: none"> – Rinse the final filter. – Vent the final filter. – If the error persists: Replace the final filter. 	8.8, page 64 8.5.3, page 58
		If the final filter has been removed and no water can be dispensed: Contact Sartorius Service.	

10 Storage and Shipping

10.1 Storage

Procedure

- ▶ If the device is in operation:
 - ▶ Decommission the device.
 - ▶ Clean the device.
- ▶ Store the device according to the ambient conditions (see Chapter "14.2 Ambient Conditions," page 73).

10.2 Returning Device and Parts

You can send defective devices or parts back to Sartorius. Returned devices must be clean, decontaminated and properly packed.

Transport damage as well as measures for subsequent cleaning and disinfection of the device or parts by Sartorius shall be charged to sender.

WARNING

Risk of injury due to contaminated equipment!

Devices contaminated with hazardous materials (NBC contamination) will **not** be accepted for repair or disposal.

- ▶ Observe the information on decontamination (see Chapter 13.1, page 71).
-

Procedure

- ▶ Decommission the device.
- ▶ Contact Sartorius Service for instructions on how to return equipment or parts (please refer to our website at www.sartorius.com for return instructions).
- ▶ Pack the device and its parts properly for return.

11 Decommissioning

Requirement

Operation has been ended correctly.

Procedure

- ▶ Start depressurization (see Chapter 8.7, page 63)
- ▶ Disconnect the device from power.
- ▶ Disconnect the device from the supply lines. Remove the consumables being used.
- ▶ Disconnect any attached components from the device.
- ▶ Clean the device (see Chapter 8, page 53).

12 Transport

12.1 Transporting the Device

Requirements

The device has been taken out of operation.

Procedure

- ▶ **NOTICE** Equipment damage due to improper transport! If the device is lifted where there are loose components, it may fall and be seriously damaged.
 - ▶ **Never** lift the device by the two side covers for transport.
 - ▶ Grip the front of the device under the display and the recess for the power supply at the back of the device and lift carefully.
- ▶ Grip the front of the device under the display and the recess for the power supply at the back of the device and lift carefully.



13 Disposal

13.1 Information on Decontamination

The device does **not** contain any hazardous materials that would necessitate special disposal measures.

If the device has come into contact with hazardous substances: Measures must be carried out to properly decontaminate and declare such devices. The operator is responsible for adhering to local legislation on the proper declaration of transport and disposal and the proper disposal of the device.

⚠ WARNING

Risk of injury due to contaminated equipment!

Devices contaminated with hazardous materials (NBC contamination) will **not** be accepted by Sartorius for repair or disposal.

13.2 Disposing of Device and Parts

13.2.1 Information on Disposal

The device and its accessories do **not** belong in regular household waste, since they are made of high-grade materials that can be recycled and reused. All parts must be disposed of properly by disposal facilities.

Batteries are installed in the device. Batteries do **not** belong in regular household waste, since they are made of high-grade materials that can be recycled and reused. Batteries must be disposed of properly by disposal facilities.

The packaging is made of environmentally friendly materials that can be used as secondary raw materials.

The consumables are designed and intended for single-use.

Hazardous Substances

The UV lamp contains mercury. The UV lamp must be delivered to an approved disposal center for hazardous substances.

13.2.2 Disposal

Requirements

If the device has come into contact with hazardous substances: The device and consumables have been decontaminated.

Procedure

- ▶ Remove the UV lamp from the device (see Chapter "8.5.5 Replacing the UV Lamp," page 60).
- ▶ Deliver the UV lamp to an approved disposal center for hazardous substances.
- ▶ Dispose of the device. Follow the disposal instructions on our website (www.sartorius.com). Inform the disposal facility that batteries are installed in the device.
- ▶ Dispose of the packaging in accordance with local government regulations.
- ▶ Dispose of the consumables in accordance with local government regulations.

14 Technical Specifications

14.1 Power Supply

	Unit	Value
Sartorius power supply, Model 1000018304		
Primary		
Voltage	V~	100 - 240 ($\pm 10\%$)
Frequency	Hz	50 to 60
Current, max.	A	2.0
Secondary		
Voltage	V=	+24 (<5%)
Current, max.	A	6.25
Short circuit protection		Electronic
Protection class according to DIN EN/IEC 60950-1		I
Operating height according to DIN EN/IEC 60529	m above sea level	Up to 3000
Power supply connection cable		
Connection plug according to DIN EN/IEC 60320-1/C14		Country-specific, 3-pin, two-sided plug
Connector according to DIN EN/IEC 60320-1/C14		3-pin
Other data		See power supply label
Device		
Power supply		Only via Sartorius power supply 1000018304
Input supply voltage	V _{DC}	+24 ($\pm 10\%$)
Current consumption, max.	A	3.0

14.2 Ambient Conditions

	Unit	Value
Environment		For indoor use only
Storage and shipping temperature	°C	+5 to +45
Operating temperature	°C	+2 to +35
Operating height	m above sea level	Up to 3000
Relative humidity	%	40 to 80

14.3 Safety of Electrical Equipment

	Unit	Value
Safety requirements according to DIN EN/IEC 61010-1		Safety requirements for electrical equipment for measurement, control and laboratory use - Part 1: General requirements

14.4 Electromagnetic Compatibility

	Unit	Value
EMC requirements according to DIN EN 61326-1		Electrical equipment for measurement, control and laboratory use – EMC requirements – Part 1: General requirements (IEC 61326-1:2012)
Interference resistance		Suitable for use in industrial areas (Table 2 of the standard)
Interference emission		Class B: Suitable for use in residential areas and areas that are connected to a low voltage network that (also) supplies residential buildings.

14.5 Product Water Quality

14.5.1 arium® mini plus

	Unit	Value (ultrapure water stage)	Value (pre-stage)
Water type		Ultrapure water ASTM Type 1	Pure water Type 3
Production output ¹	l/h	–	8
Water dispensing flow rate ²	l/min	≤ 1.0	without pressure via ball cock
Volume-controlled dispensing ²	l	Between 0.05 and 5 (in 50-ml increments)	–
Typical conductivity	µS/cm	0.055 (compensated to 25 °C ⁵)	< 20
Typical resistance	MΩ × cm	18.2 (compensated to 25 °C ⁵)	< 0.05
TOC content ³ (system with UV lamp)	ppb	< 5	–
Microorganism content ⁴	CFU/1.000 ml	< 1	< 1
Particle content > 0.2 µm ⁴	ml ⁻¹	< 1	< 1
Typical ion retention	%	–	≤ 98
Retention of dissolved organic substances (MW > 300 Dalton)	%	–	> 99
Particle and microorganism retention	%	–	> 99

¹ Depending on the feed water pressure, temperature and condition of the RO modules

² Depending on the hydrostatic pressure, and connected accessories and/or final filter

³ Determined with municipal water (Goettingen), TOC approx. 1000 ppb

⁴ When using an arium® SterilePlus final filter (Sartopore® 2 150)

⁵ Measurement output adjustable compensated to 25 °C or uncompensated

14.5.2 arium® mini and arium® mini essential

	Unit	Value
Water type		Ultrapure water ASTM Type 1
Water dispensing flow rate ²	l/min	≤ 1.0
Volume-controlled dispensing ²	l	Between 0.05 and 5 (in 50-ml increments)
Typical conductivity	μS/cm	0.055 (compensated to 25 °C ⁵)
Typical resistance	MΩ × cm	18.2 (compensated to 25 °C ⁵)
TOC content ³ (system with UV lamp)	ppb	< 5
Microorganism content ⁴	CFU/1.000 ml	< 1
Particle content > 0.2 μm ⁴	ml ⁻¹	< 1

² Depending on the hydrostatic pressure, and connected accessories and/or final filter

³ Determined with municipal water (Goettingen), TOC approx. 1000 ppb

⁴ When using an arium® SterilePlus final filter (Sartopore® 2 150)

⁵ Measurement output adjustable compensated to 25 °C or uncompensated

14.6 Feed Water Quality

14.6.1 arium® mini plus

	Unit	Value
Suitability / type		Exclusively potable tap water pursuant to the drinking water standards of the USA, the European Union or Japan.
Inlet pressure	bar	0.5 to 6 (recommended: > 2)
Temperature	°C	2 to 30
TOC	ppb	< 2,000
Max. total hardness (max. CaCO ₃)	ppm	360
Free chlorine	ppm	< 4
Iron (total Fe content)	ppm	< 0.1
Fouling Index (SDI)		< 10
Turbidity	NTU	< 1
pH value		4 to 10

14.6.2 arium® mini

	Unit	Value
Suitability / type		Purified water using reverse osmosis, distillation or deionization
Inlet pressure		Depressurized
Temperature	°C	2 to 30
Specific conductivity	µS/cm	< 100 (compensated to 25 °C)
TOC	ppb	< 50
Turbidity	NTU	< 1
pH value		4 to 10

14.6.3 arium® mini essential

	Unit	Value
Suitability / type		Purified water using reverse osmosis, distillation or deionization
Inlet pressure		0 to 6 (recommended: > 2)
Temperature	°C	2 to 30
Specific conductivity	µS/cm	< 100 (compensated to 25 °C)
TOC	ppb	< 50
Turbidity	NTU	< 1
pH value		4 to 10

14.7 Device Properties

	Unit	Value
Dimensions (width × height × depth)	mm	280 × 509.4 × 530.7
Empty weight, approx.	kg	13
Operating weight, approx.	kg	23
Water treatment method		Adsorption by means of spherical activated carbon, catalyst, reverse osmosis, ion exchange, optional UV irradiation and final particle / sterile filtration or removal of endotoxin, RNase and DNase

15 Consumables

This table contains an excerpt of accessories that can be ordered. For information on other products, contact Sartorius.

Description	Order number
Final filter	
arium® sterile filter SterilePlus (Sartopore® 2 150 capsule)	5441307H4--CE
arium® CellPlus ultrafilter	H20-CUF
arium® pretreatment cartridge ¹	H20-CPR
arium® Scientific Pack (ultrapure water cartridge)	H20-S-PACK
arium® 5-liter bag ²	H20-CBS-5-S
arium® UV lamp	H20-CEL1

¹ Only required for arium® mini plus

² Only required for arium® mini plus or arium® mini

16 Sartorius Service

The Sartorius Service is at your disposal for queries regarding the device. For information about the service addresses, services provided or to contact a local representative, please visit the Sartorius website (www.sartorius.com).

When contacting Sartorius Service with questions about the system or in the event of malfunctions, be sure to keep the device information—e.g. serial number, hardware, firmware, configuration—close at hand. This information can be found on the manufacturer's ID label and in the "Device Information" menu.

17 Conformity

17.1 EU Declaration of Conformity

The attached Declaration of Conformity hereby confirms compliance of the device with the directives cited.

17.2 CSA Declaration of Conformity

The attached Declaration of Conformity hereby confirms compliance of the device with the directives cited.



Original



sartorius

EG-/EU-Konformitätserklärung EC / EU Declaration of Conformity

Hersteller
Manufacturer Sartorius Lab Instruments GmbH & Co. KG
37070 Goettingen, Germany

erklärt in alleiniger Verantwortung, dass das Betriebsmittel
declares under sole responsibility that the equipment

Geräteart
Device type Reinstwassersystem arium® mini plus, arium® mini, arium® mini essential
Ultrapure water treatment system arium® mini plus, arium® mini, arium® mini essential

Baureihe
Type series H20-MA-T, H20-MA-T-US, H20-MA-UV-T, H20-MA-UV-T-US (arium® mini plus)
H20-MM-T, H20-MM-T-US, H20-MM-UV-T, H20-MM-UV-T-US (arium® mini)
H20-MU-T, H20-MU-T-US, H20-MU-UV-T, H20-MU-UV-T-US (arium® mini essential)

in der von uns in Verkehr gebrachten Ausführung allen einschlägigen Bestimmungen der folgenden Europäischen Richtlinien - einschließlich deren zum Zeitpunkt der Erklärung geltenden Änderungen - entspricht und die anwendbaren Anforderungen folgender harmonisierter Europäischer Normen erfüllt:
in the form as delivered fulfils all the relevant provisions of the following European Directives - including any amendments valid at the time this declaration was signed - and meets the applicable requirements of the harmonized European Standards listed below:

2014/30/EU Elektromagnetische Verträglichkeit
Electromagnetic compatibility
EN 61326-1:2013

2006/42/EG
2006/42/EC Maschinen
Machines
EN ISO 12100:2010, EN 61010-1:2010

2011/65/EU Beschränkung der Verwendung bestimmter gefährlicher Stoffe in Elektro- und Elektronikgeräten (RoHS)
Restriction of the use of certain hazardous substances in electrical and electronic equipment (RoHS)
EN 50581:2012

Die Person, die bevollmächtigt ist, die technischen Unterlagen zusammenzustellen:
The person authorised to compile the technical file: Sartorius Lab Instruments GmbH & Co. KG
International Certification Management
37070 Goettingen, Germany

Jahreszahl der CE-Kennzeichenvergabe | *Year of the CE mark assignment:* 17

Sartorius Lab Instruments GmbH & Co. KG
Goettingen, 2017-06-30

Dr. Reinhard Baumfalk
Vice President R&D

Dr. Dieter Klausgrete
Head of International Certification Management

Diese Erklärung bescheinigt die Übereinstimmung mit den genannten EG- und EU-Richtlinien, ist jedoch keine Zusicherung von Eigenschaften. Bei einer mit uns nicht abgestimmten Änderung des Produktes verliert diese Erklärung ihre Gültigkeit. Die Sicherheitshinweise der zugehörigen Produktdokumentation sind zu beachten.

This declaration certifies conformity with the above mentioned EC and EU Directives, but does not guarantee product attributes. Unauthorised product modifications make this declaration invalid. The safety information in the associated product documentation must be observed.

Doc: 2036499-03 SLI15CE018-03.de,en 1 / 1 PMF: 2036498 OP-113_fo1_2015.10.12



Certificate of Compliance

Certificate: 70055155

Master Contract: 167555

Project: 70055155

Date Issued: 2016-01-15

Issued to: Sartorius Lab Instruments GmbH & Co. KG
94-108 Weender Landstrasse
Goettingen, 37075
GERMANY

The products listed below are eligible to bear the CSA Mark shown with adjacent indicators 'C' and 'US' for Canada and US or with adjacent indicator 'US' for US only or without either indicator for Canada only.



Issued by: Marilyn Laroche
Marilyn Laroche

PRODUCTS

CLASS - C872106 - LABORATORY EQUIPMENT-Electrical

CLASS - C872186 - ELECTRICAL EQUIPMENT FOR LABORATORY USE-Certified to US Standards

For details related to rating, size, configuration, etc. reference should be made to the CSA Certification Record or the descriptive report.

Water Treatment System models:

- Arium[®] mini :
 - Models : H2O-Mx-UV-T and H2O-Mx-T (x = M or U)
- Arium[®] mini plus :
 - Models : H2O-MA-UV-T and H2O-MA-T.

Nomenclature :

- U: unit is equipped with a ultrapure water treatment loop (including a ultrapure water cartridge, a flow meter, conductivity cell and a dispense valve);
- M: unit is additionally (related to variant U) equipped with a bag and a pump for filling is the same;
- A: unit is additionally (related to variant M) equipped with a prefilter-RO-module-cartridge combination, a pressure regulator and a flushing valve;
- UV: Unit with suffix UV is additionally (related to H2O-Mx-T) equipped with an UV light system
- T: Desktop version



Certificate: 70055155

Master Contract: 167555

Project: 70055155

Date Issued: 2016-01-15

Rating: 24 Vdc; 3,0 A (max.). For use with the power supply: FSP, Model FSP150-AAAN2 (Sartorius model 1000018304): Input: 100-240Vac, 50-60Hz, 2A, Output: 24Vdc, 6.25A.

Notes:

1. The above model has been evaluated for use in a Pollution Degree 2, Installation Category II.
2. Mode of operation: Continuous
3. Environmental Conditions: Normal: +2 to +35 C, 3000m max, 40 to 80% rH non-condensing.
4. The unit has been evaluated for use in ordinary dry locations only and indoors only.

APPLICABLE REQUIREMENTS

CSA Standards:

CAN/CSA-C22.2 No. 61010-1-12 - Safety Requirements for Electrical Equipment for Measurement, Control, and Laboratory Use, Part 1: General Requirements

UL Standards:

UL Std. No. 61010-1 (3rd Edition) - Safety Requirements for Electrical Equipment for Measurement, Control, and Laboratory Use - Part 1: General Requirements

CONDITIONS OF ACCEPTABILITY

- (1) The main supply cord set provided with the equipment must be an approved type acceptable to the authorities in the country where the equipment is sold.
- (2) Units provided with other than North American Certified power supply cord sets are certified as a component. Cord length should be not more than 3 m.
- (3) Unit is intended to be used with the power supply: FSP, Model FSP150-AAAN2 (Sartorius model 1000018304).
- (4) Plug of detachable power supply cord was considered as a disconnect device.
- (5) The equipment has been evaluated for use in a Pollution Degree 2 and overvoltage category II environment and a maximum altitude of 3000 m.
- (6) The product was evaluated for maximum ambient temperature 40°C, although maximum operation ambient temperature for the unit is 35°C.
- (7) The user replaceable mains (line) fuse must be an approved type acceptable to the authorities where the equipment is sold.
- (8) Equipment is not to be used with flammable liquids.
- (9) Equipment has only been tested for electrical safety. No evaluation of functional safety and performance characteristics has been conducted.

Sartorius Lab Instruments GmbH & Co. KG
Otto-Brenner-Strasse 20
37079 Goettingen, Germany

Phone: +49.551.308.0
Fax: +49.551.308.3289
www.sartorius.com

The information and figures contained in these instructions correspond to the version date specified below.

Sartorius reserves the right to make changes to the technology, features, specifications and design of the equipment without notice.

Masculine or feminine forms are used to facilitate legibility in these instructions and always simultaneously denote the other gender as well.

Copyright notice:

This instruction manual, including all of its components, is protected by copyright. Any use beyond the limits of the copyright law is not permitted without our approval. This applies in particular to reprinting, translation and editing irrespective of the type of media used.

© Sartorius Germany

Last updated:
07 | 2017